

**Application**

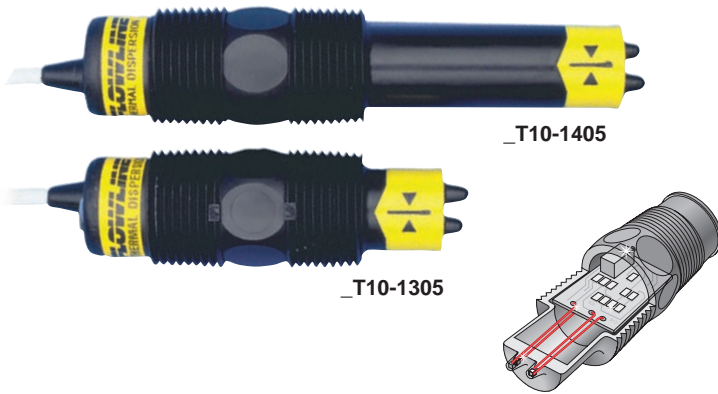

Offered in liquid and gas sensor types, the general purpose flow switch provides reliable low or no-flow detection of relatively clean, non-coating media with one 1A relay output. Liquid examples include water and acetic acid. Available in Polypropylene-Ryton® and PVDF, the short flow sensor is used in pipe or ducting from 1/2" to 1 1/2", and the long flow sensor is used in 2" and up. The flow switch set point may be adjusted from 0.04 to 3 fps in liquids, or 1 to 90 fps in gases as a low-flow alarm. The flow sensor is best applied in applications with relatively constant temperature.



**Features**

- ✓ Rugged Polypropylene-Ryton® or PVDF sensor for corrosive liquids and gases
- ✓ Adjustable set point with LED for flow or no-flow status indication
- ✓ 60VA relay selectable NO or NC via power supply wiring polarity
- ✓ Solid state sensor is not damaged by over-ranging flow velocities

**Key Benefits**

- ✓ Ideal for monitoring chemical feed pumps
- ✓ Use to monitor flow/no-flow conditions
- ✓ Add FT50-\_000 for metering pump/tubing installations

**Compatible Products**

**Thermo-Flo™ Remote Level Controller**



**Application**

The general purpose flow controller is offered in two configurations for low-flow pump and process protection. The LC80 accepts one flow sensor input and provides one 10A relay for low flow control. The LC82 accepts two flow sensor inputs and provides two 10A relays for dual low flow control. Package this flow controller with our liquid or gas flow switch sensors. For field mount installation, add a single or dual controller NEMA box.

**Thermo-Flo™ Compact Level Controller**



**Application**

The general purpose flow controller accepts one flow sensor input, and provides one 10A relay for low-flow pump or process protection. The optional flash alarm brings attention to low-flow alarm conditions. Package this flow controller with our liquid or gas flow switch sensors.

## Specifications

Set point range: FT10: 0.04 to 3 fps  
(0.012 to 0.91 mps)  
GT10: 1 to 90 fps  
(0.3 to 27 mps)

Factory set point: FT10: 2fps (.06 mps)  
GT10: 10 fps (3 mps)

Repeatability: ± 0.5% of set point  
@ fixed temperature

Response time: 1-10 seconds

Set point adjust.: Potentiometer

Viscosity range: FT10: 1-200 centipoise

LED indication: Flow status

Supply voltage: 12-36 VDC

Consumption: 70 mA maximum

Contact type: (1) SPST relay

Contact rating: 60 VA, 1A maximum

Contact output: Selectable NO / NC

Process temp.: F: 32° to 140°  
C: 0° to 60°

Ambient temp.: F: -40° to 140°  
C: -40° to 60°

Pressure: 150 psi (10 bar) @ 25°  
C, derated @ 1.667  
psi (0.113 bar) per °C  
above 25° C

Sensor rating: NEMA 4X (IP65)

Wetted material: -1XX5: PP-Ryton®  
-5XX5: PVDF

Cable jack. mat.: -1XX5: PP  
-5XX5: PFA

Cable type: 4-conductor, shielded  
#22 AWG

Cable length: 10' (3m)

Process mount: 3/4" NPT (3/4" G)

Mount. gasket: Viton®

Classification: General purpose

Compliance: CE

## Dimensions

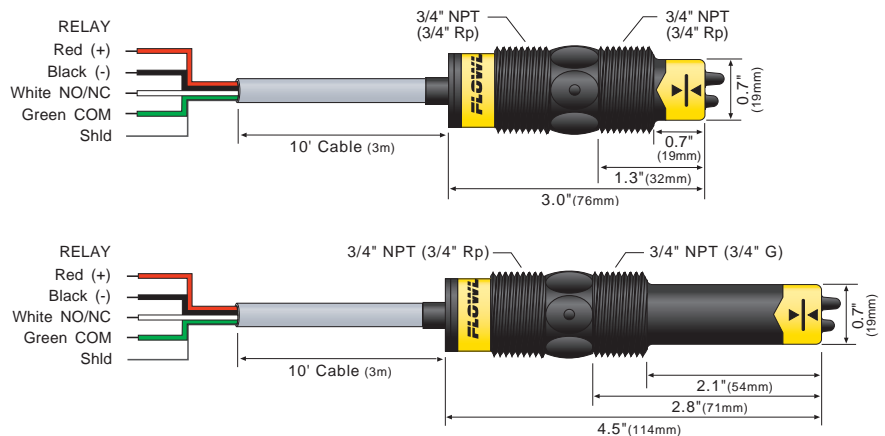

## Accessories

If the required FT10 application experiences conditions of pulsing flow, please consider the Flow Switch Fitting below.



P/N	Description
FT50-5000	Flow Switch Fitting

## Mounting

### FT10/GT10 Special Mounting Instructions

When using any type of fitting, the orientation as well as the insertion depth of the flow switch in the pipe is critical. Recommended orientation and depth is represented by the following diagram. For more information reference the FT10/GT10 manual at [www.flowline.com/technical\\_lit.php](http://www.flowline.com/technical_lit.php)

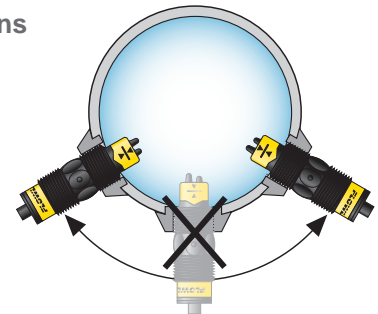

## Ordering

T10-5

### Application media

F Liquid  
G Gas

### Sensor material (1)

1 PP / Ryton  
5 PVDF

### Sensor length (2)

3 Short  
4 Long

### Process mount (3)

0 NPT (US)  
2 G / Rp (Metric)

## Notes

- To special order a 25' (7.6m) or 50' (15.2 m) flow sensor cable, place the cable length at the end of the part number (ie: FT10-1305-25'). For PP, add \$20 for 25' (7.6m) or \$40 for 50' (15.2m) to the price. For PFA, add \$75 for 25' (7.6m) or \$150 for 50' (15.2m) to the price.
- Order the short sensor for use with pipe sizes from 3/4"-1 1/2" (D25-D50), and the long sensor for 2" and higher (D63 up).
- The metric flow sensor has straight G threads on the sensing side, and conical Rp threads on the cable side of the wrench flat.