

# FLOW RATE INDICATOR / TOTALIZER

WITH LINEARIZATION AND ANALOG / PULSE  
SIGNAL OUTPUTS



## Advantages

- Robust IP67 (NEMA Type4X) field enclosure. It is so rugged, **you can even stand on it!**
- Intrinsically Safe available - ATEX and IECEx approval for gas and dust applications.
- Programming can be done by your own crew, with the sensible menu-driven structure, saving cost and irritation. **Know one, know them all!**
- Very diverse mounting possibilities: walls, pipes, panels or directly onto outdoor sensors!

## Features

- Displays instantaneous flow rate, total and accumulated total.
- 15 point linearization of the flowcurve - with interpolation.
- Large 17mm (0.67") digits for flow rate or total.
- Selectable on-screen engineering units; volumetric or mass.
- Auto backup of settings and running totals.
- Explosion/flame proof available.
- Full Modbus communication RS232/485/TTL.
- Loop or battery powered, 8 - 24V AC/DC or 115 - 230V AC power supply.
- Sensor supply 3 / 8.2 / 12 / 24V DC.
- LED backlight option.

## Signal output

- (o)4 - 20mA / 0 - 10V DC according to linearized flow rate.
- Scaled pulse output according to linearized accumulated total.

## Signal input

### Flow

- Ability to process all types of flow meter signals: Reed-switch, NAMUR, NPN/PNP pulse, Sine wave (coil), Active pulse signals, (o)4 - 20mA, 0 - 10V DC.

## Applications

- The F-Series is your first and safest choice for field mount indicators in safe and hazardous area applications. Especially in harsh weather conditions like rain, snow, salty atmospheres and temperatures between -40°C up to +80°C (-40°F up to 176°F).
- Liquid flow measurement with mechanical flow meters where a precise calculation over the full measurement range is required. Also re-transmission of the flow rate and/or totalizer functions or serial communication is desired. Alternative basic model: Fo16 or more advanced F118 or the D-Series DIN panel mount flow rate indicators.

## General information

### Introduction

The F112 provide very precise linearization of the flow meters signal. In addition to the average K-Factor or Span, fifteen linearization points can be entered with there frequencies or values.

The unit will interpolate between these points greatly enhancing accuracy in any flowrange. Even for very low frequency applications is catered for. This linearization effects all displayed information as well as the signal outputs. A wide selection of options further enhances the capabilities of this model, which includes Intrinsic Safety and full Modbus communication.

### Display

The display has large 17mm (0.67") and 8mm (0.31") digits which show flow rate and totals. On-screen engineering units are easily configured from a comprehensive menu. The linearized accumulated total can register up to 11 digits and is backed-up in EEPROM memory every minute.

### Configuration

All configuration settings are accessed via a simple operator menu which can be password protected. Each setting is clearly indicated with an alphanumerical description, which avoids confusing abbreviations. Once familiar with one F-series product, you will be able to program all models in the series without a manual. All settings are safely stored in EEPROM memory in the event of sudden power failure.

### Analog output signal

The linearized flow rate is re-transmitted with the (o)4 - 20mA or 0 - 10V DC output signal. The output signal is updated eight times per second with a filter function being available to smoothen out the signal if desired.

The output value is user defined in relation to the flow rate, e.g. 4mA equals to 15L/Hr and 20mA equals to 2000L/Hr. The output signal can be passive, active or isolated where the passive output type will loop power the F112 as well.

### Pulse output

The scaleable pulse output, reflects the count on the accumulated display. The pulse length is user defined from 0.001 second up to 9.999 seconds. The maximum output frequency is 500Hz.

The output signal can be a passive NPN, active PNP or an isolated electro-mechanical relay.

### Signal input

The F112 accepts most pulse and analog input signals for volumetric flow or mass flow measurement. The input signal type can be selected by the user in the configuration menu without having to adjust any sensitive mechanical dip-switches. The analog input is available with lineair and square root calculation.

### Communication

All process data and settings can be read and modified manually or through the Modbus communication link (RS232 / RS485).

Full Modbus functionality remains available for the Intrinsically Safe version (TTL).

### Hazardous areas

This model has been ATEX and IECEx certified Intrinsically Safe for gas and dust applications, with an allowed ambient temperature of -40°C to +70°C (-40°F to +158°F).

A flame proof Ex d enclosure with ATEX certification is also available.

### Enclosures

Various types of enclosures can be selected, all ATEX and IECEx approved. As standard the F112 is supplied in an GRP panel mount enclosure, which can be converted to an IP67 / NEMA Type4X GRP field mount enclosure by the addition of a back case. Most popular is our rugged aluminum field mount enclosure with IP67 / NEMA Type4X rating. Both European or U.S. cable gland entry threads are available.

## Overview application F112

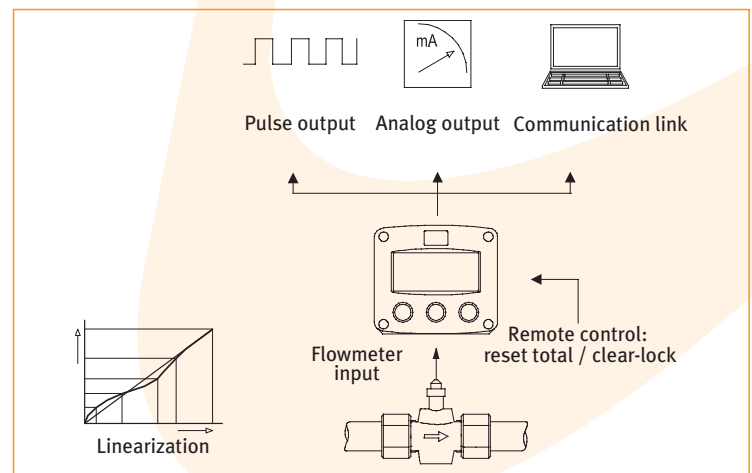

## Dimensions enclosures

### Aluminum & GRP panel mount enclosure

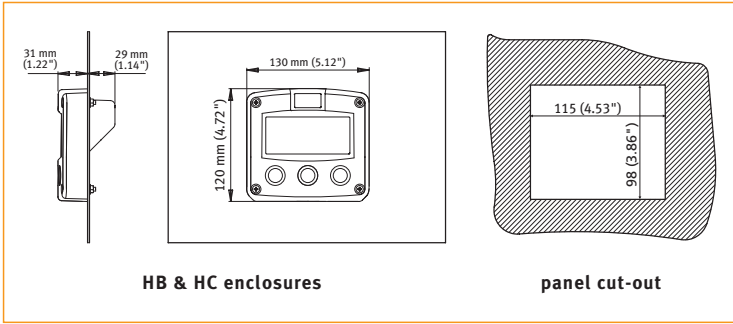

### Aluminum & GRP field / wall mount enclosures

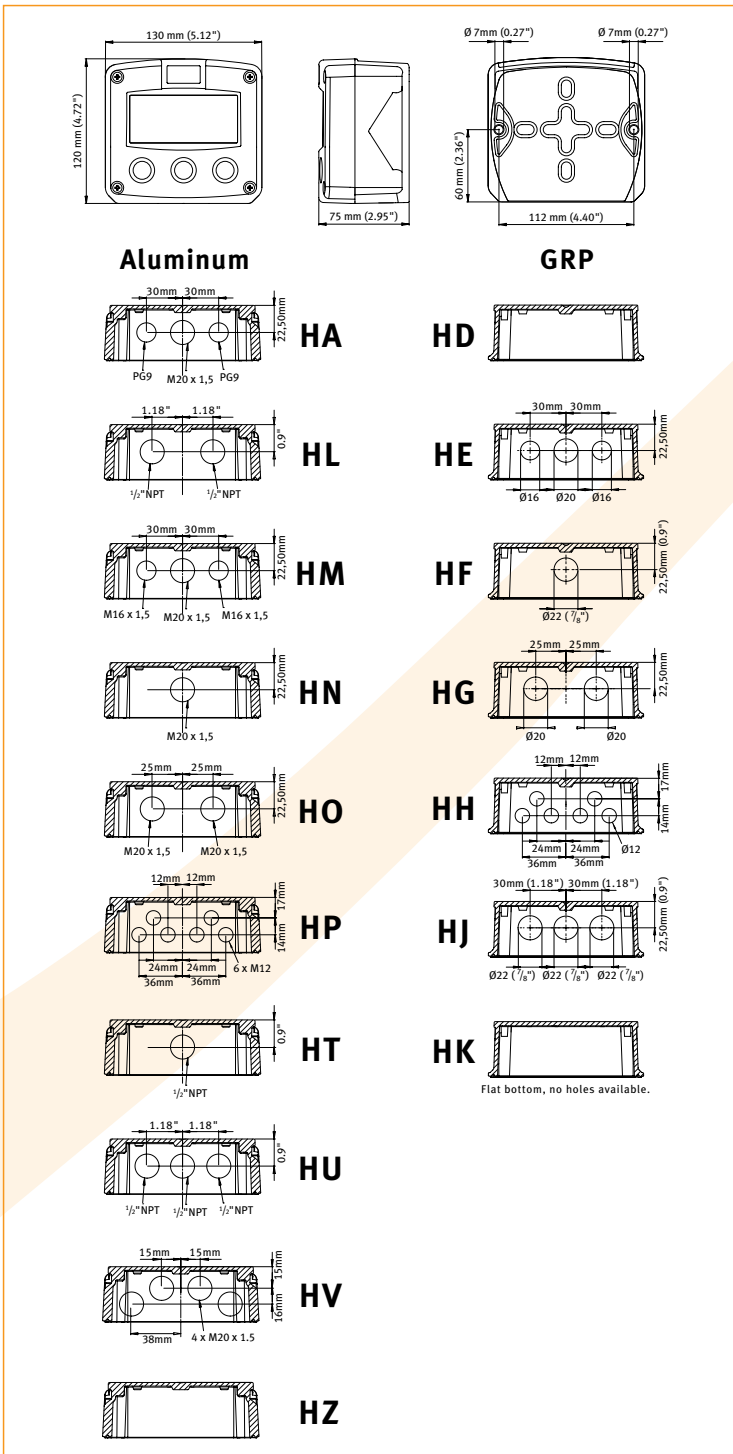

## Terminal connections

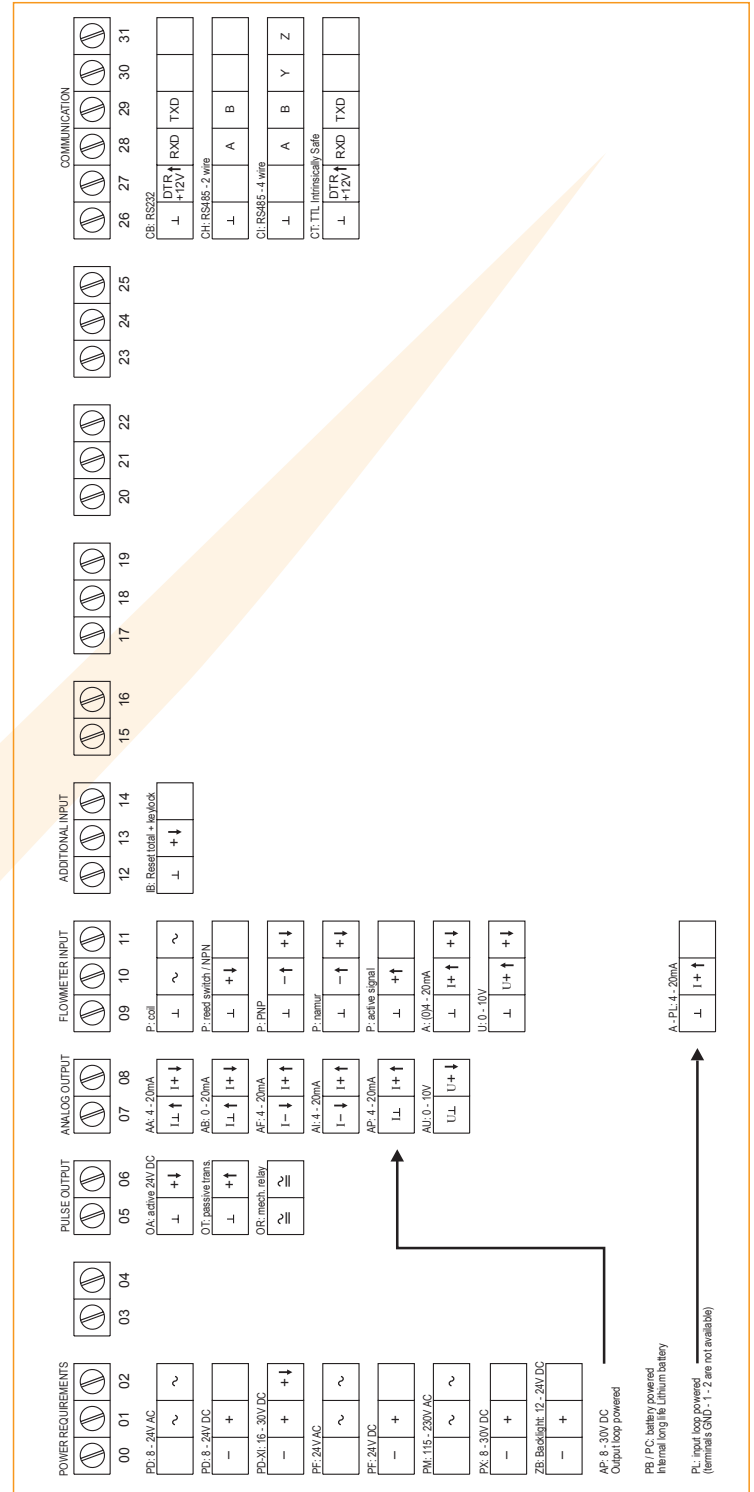

### Display example - 90 x 40mm (3.5" x 1.6")

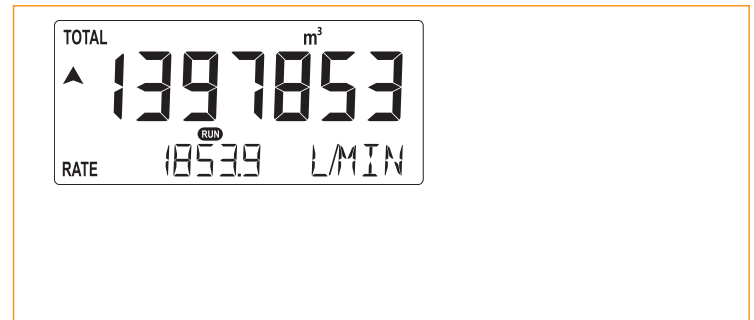

Typical wiring diagram F112-P-(AP)-CH-IB-(OT)-PB-(PX)

Typical wiring diagram F112-P-AP-CH-IB-OT-PX

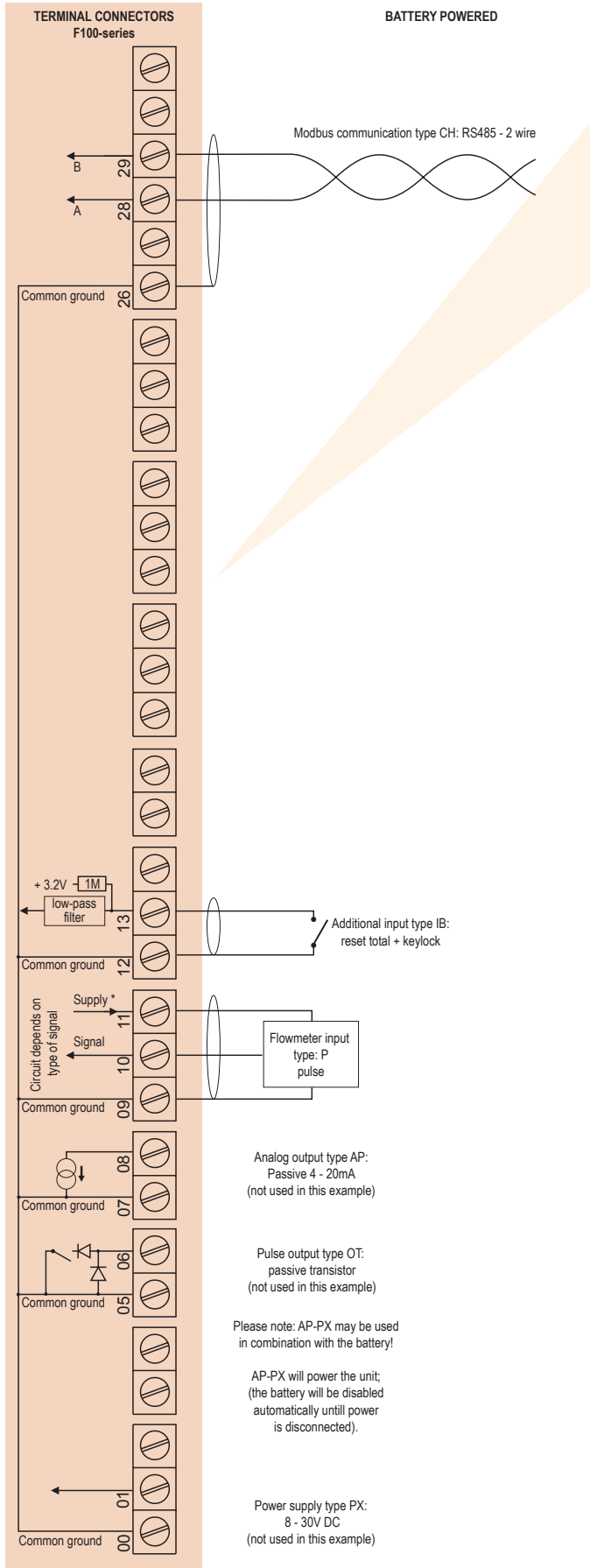

\* Supply voltage: 1.2 / 3.2V DC to sensor

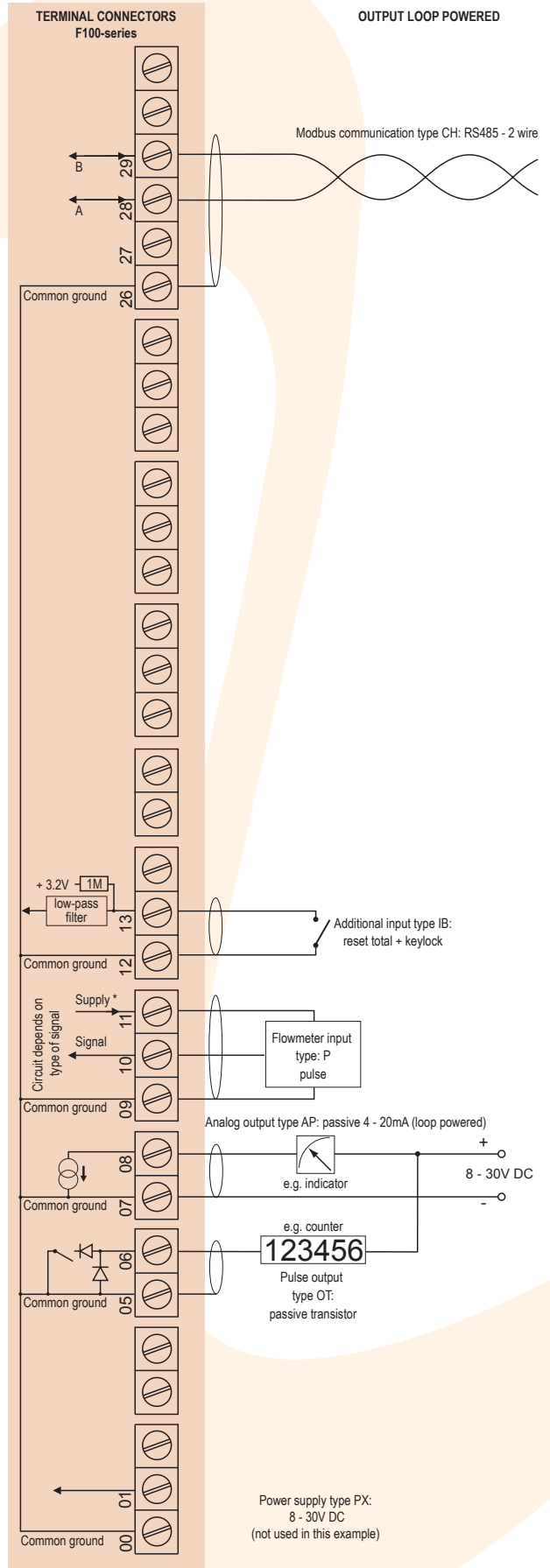

\* Supply voltage: 1.2 / 3.2V DC to sensor

Typical wiring diagram F112-A-AA-CB-IB-OA-PD

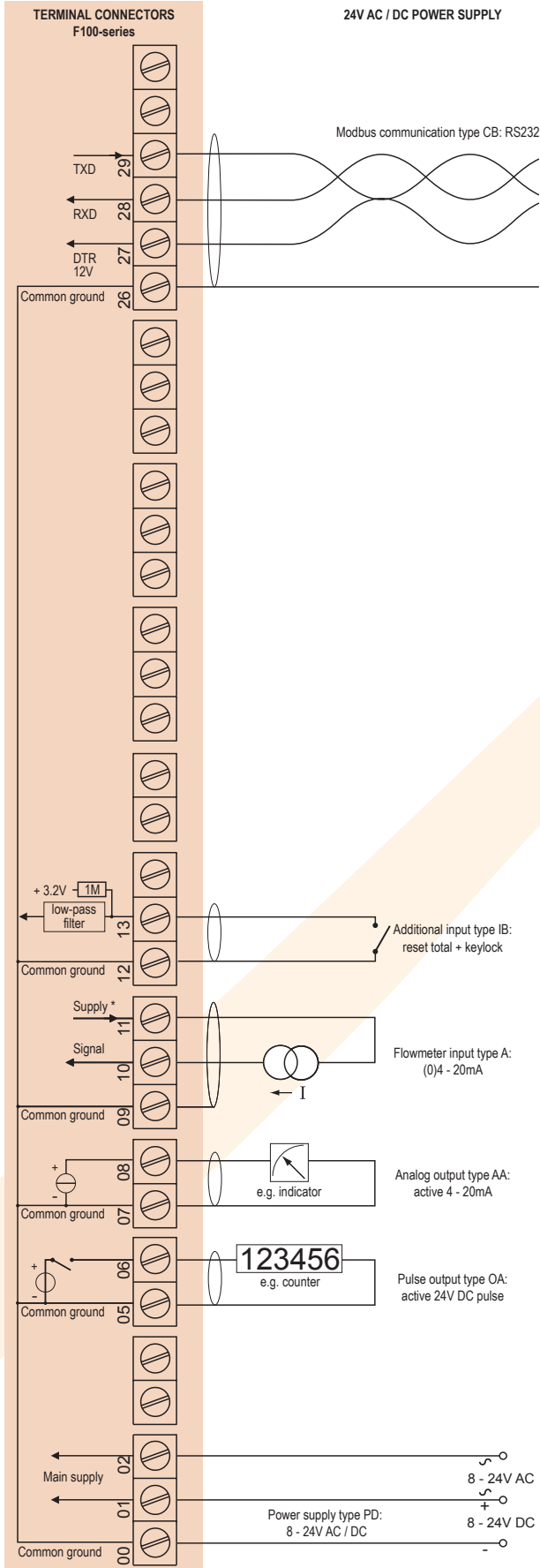

\* Supply voltage: 3.2 / 8.2 / 12 / 24V DC to sensor

Typical wiring diagram F112-A-AI-CI-IB-OR-PM

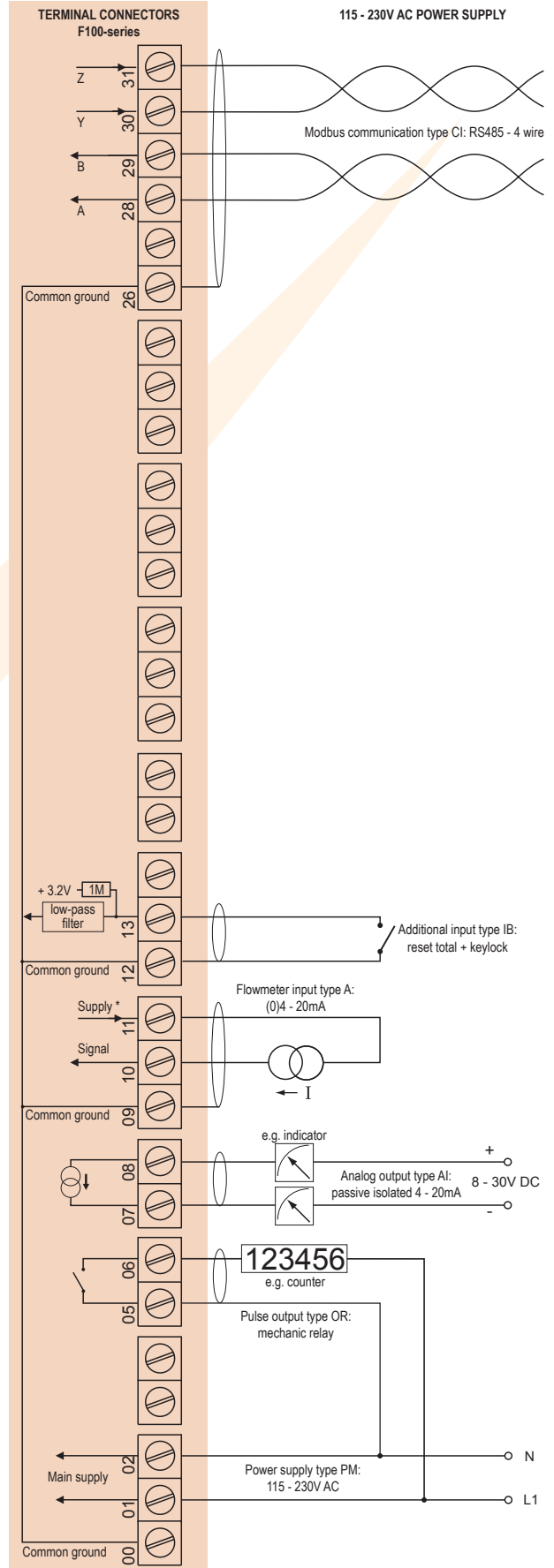

\* Supply voltage: 3.2 / 8.2 / 12 / 24V DC to sensor

## Hazardous area applications

The F112-XI has been certified according ATEX and IECEx by DEKRA for use in Intrinsically Safe applications with an ambient temperature of -40°C to +70°C (-40°F to +158°F).

- The ATEX markings for gas and dust applications are:

**II 1 G Ex ia IIB/IIC T4 Ga**  
**II 1 D Ex ia IIIC T100 °C Da IP6X.**

- The IECEx markings for gas and dust applications are: **Ex ia IIC/IIB T4 Ga** and **Ex ia IIIC T100 °C Da IP6X.**

Besides the I.S. power supply for the pulse output, it is allowed to connect up to three I.S. power supplies in IIB/IIIC applications or one in IIC applications. Consult the certificate for the maximum input and output values of the circuits. Full functionality of the F112 remains available, including 4 - 20mA output, pulse output and Modbus communication (type CT). Power supply type PD-XI offers a 8.2V sensor supply e.g. for one Namur sensor. An ATEX approved flame proof Ex d enclosure is available as well. Please contact your supplier for further details.

**Certificate of conformity KEMA 03ATEX1074 X**  
**• IECEx DEK 11.0042X**

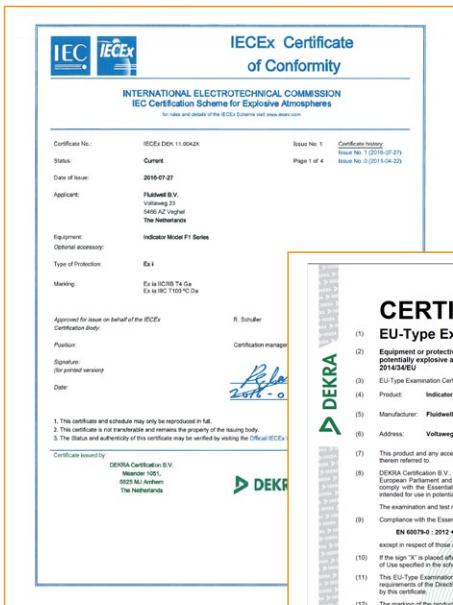

## Configuration example IIB / IIIC and IIC F112-P-(AP)-(CT)-IB-(OT)-PC-XI - Battery powered unit

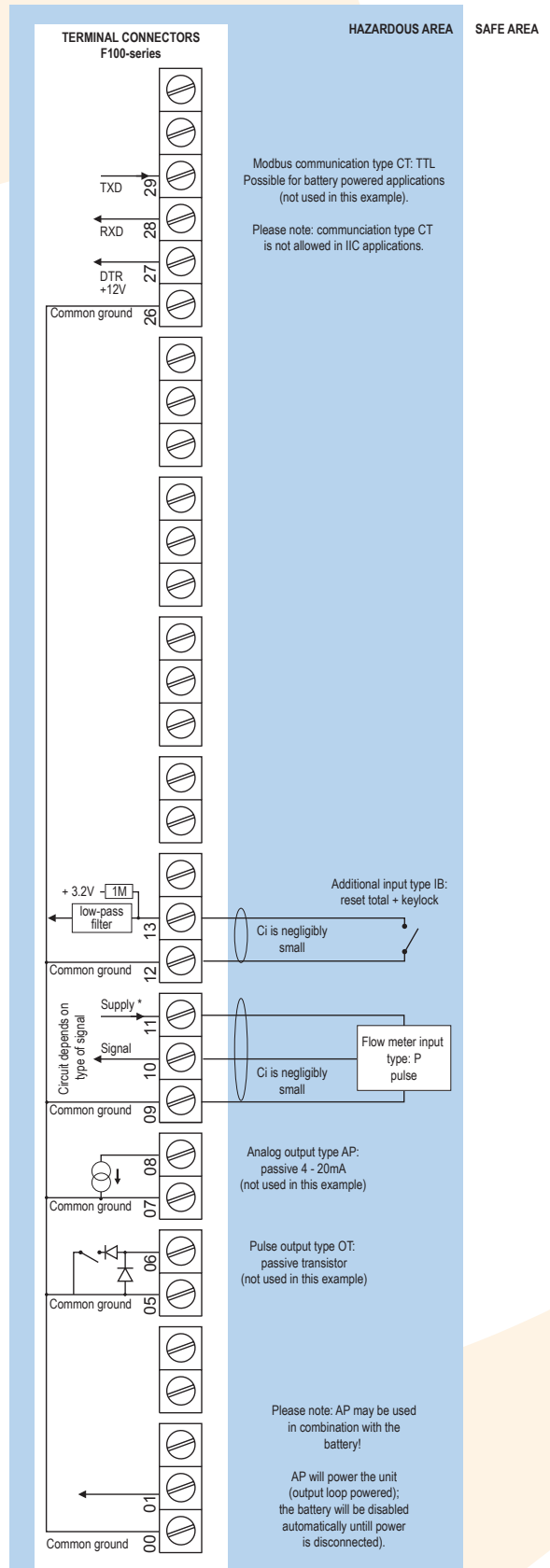

\* Note sensor supply voltage: 1.2V DC for coil sensors or 3.2V DC for other pulse sensors.

**Configuration example IIB / IIIC and IIC - F112-P-AP-(CT)-IB-OT-(PX)-XI - Output loop powered**

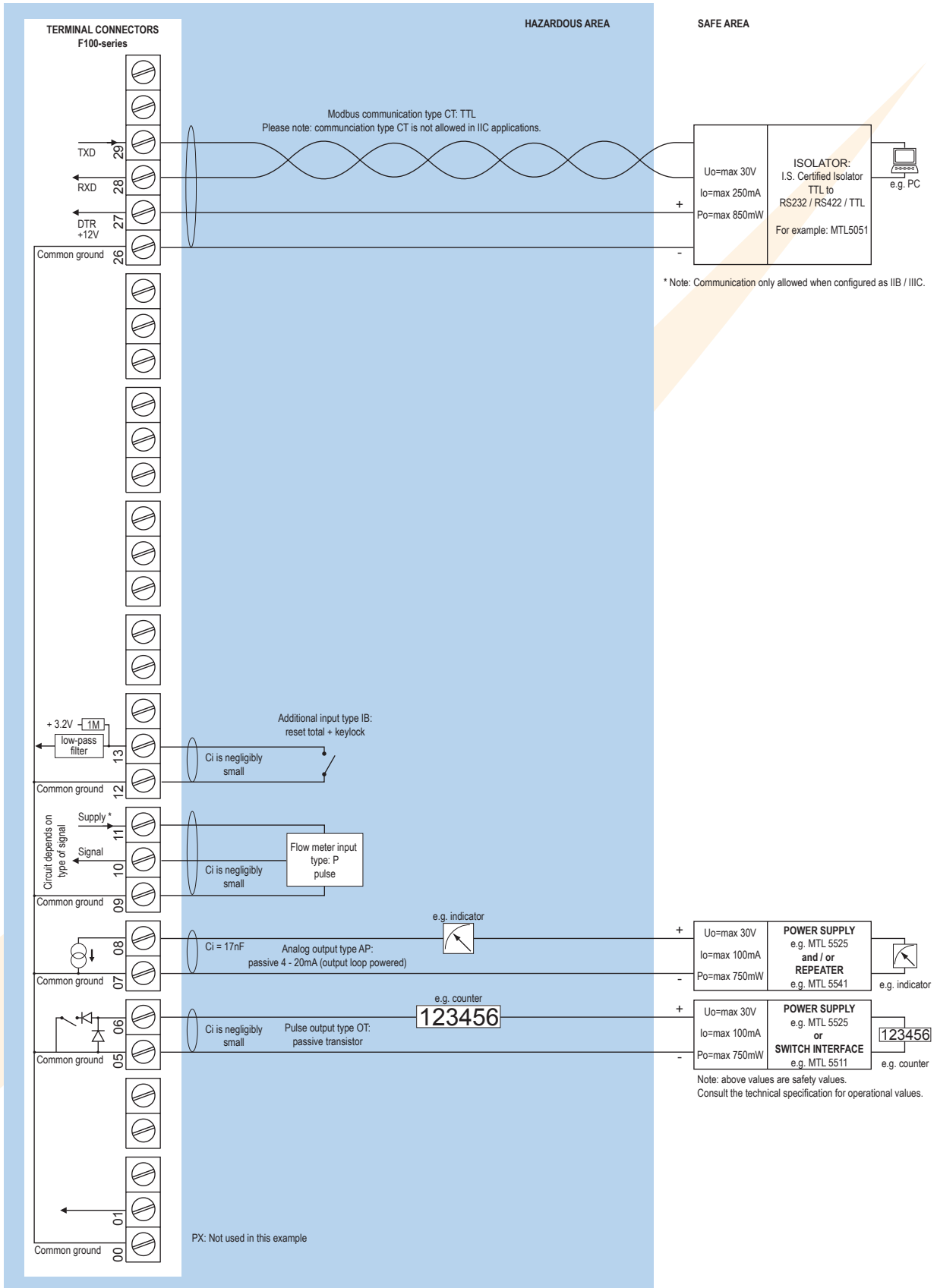

\* Note sensor supply voltage: 1.2V DC for coil sensors or 3.2V DC for other pulse sensors.

# Configuration example IIB / IIIC and IIC - F112-A-AF-(CT)-IB-OT-PD-XI - Power requirement 16 - 30V DC

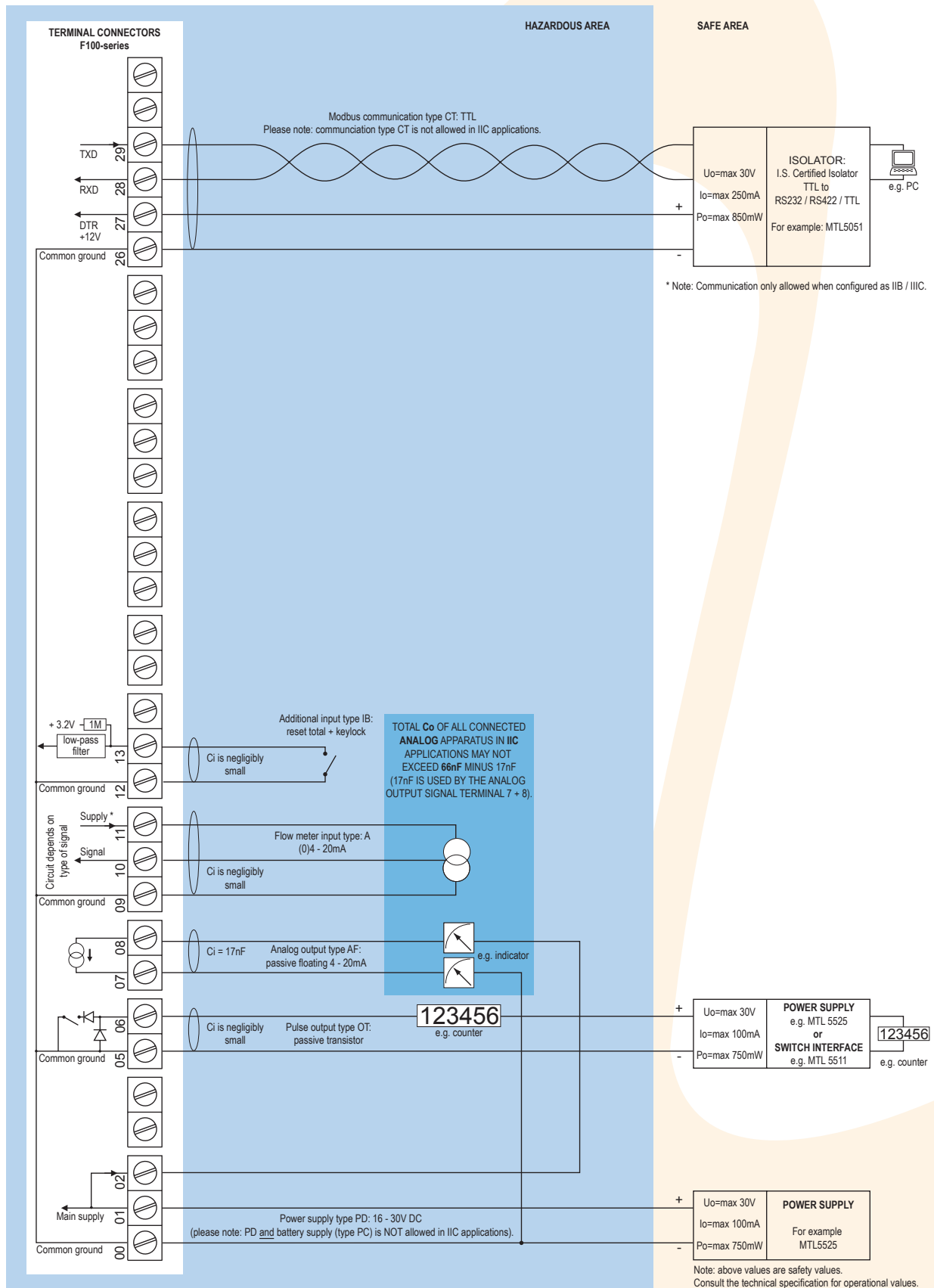

\* Note power supply type PD: the supply voltage to pulse sensors is maximum 8.7V (U<sub>o</sub>=max 8.7V I<sub>o</sub>=max 25mA P<sub>o</sub>=max 150mW) and to analog sensors as connected to terminal 1 (internally linked).



**Configuration example IIB / IIIC - F112-A-AF-CT-IB-OT-(PC)-(PD)-XI - Power requirement 16 - 30V DC or battery powered**

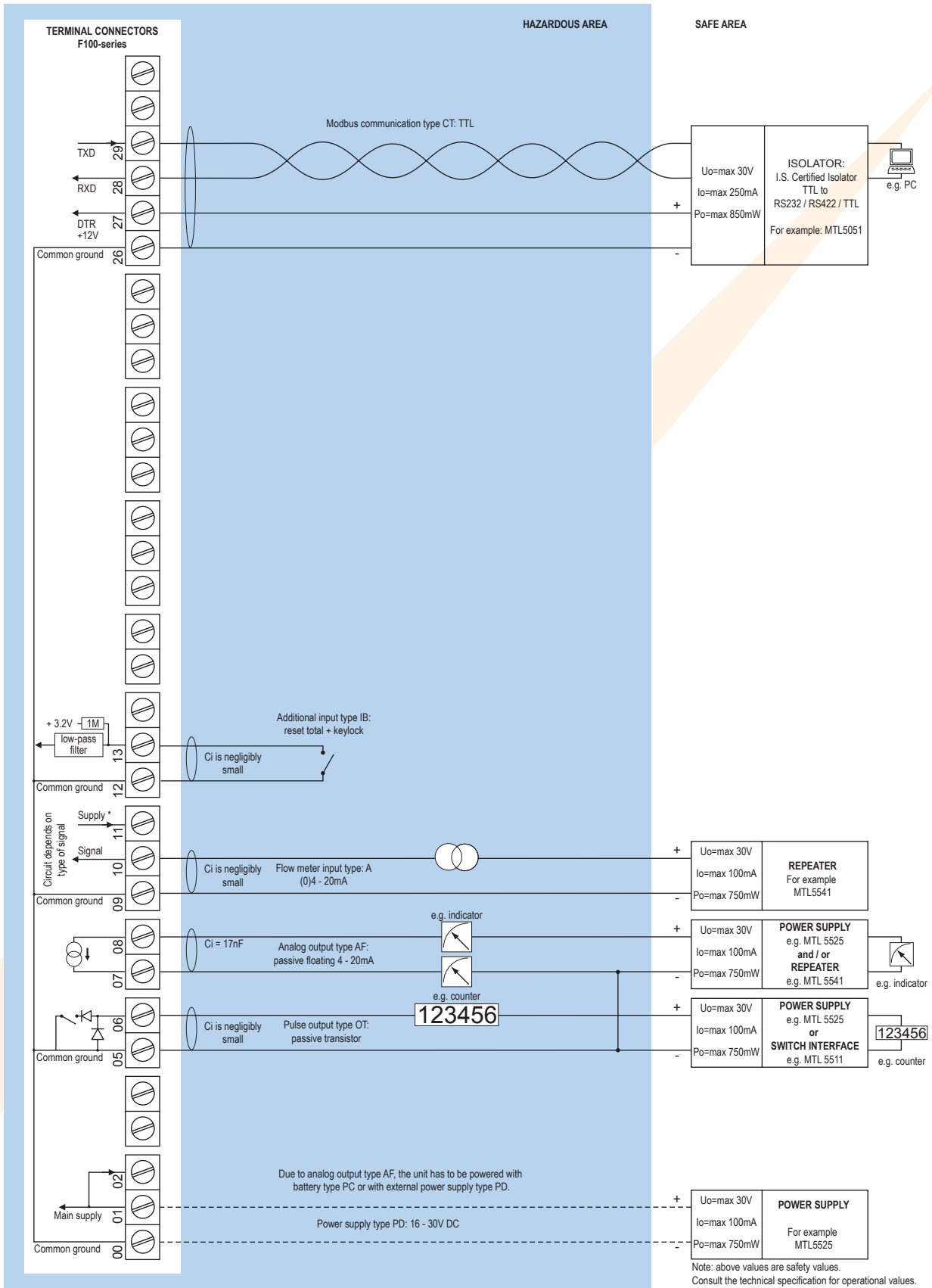

\* Note power supply type PD: the supply voltage to pulse sensors is maximum 8.7V (U<sub>o</sub>=max 8.7V I<sub>o</sub>=max 25mA P<sub>o</sub>=max 150mW) and to analog sensors as connected to terminal 1 (internally linked).

## Technical specification

### General

Display	
Type	High intensity reflective numeric and alphanumeric LCD, UV-resistant.
Dimensions	90 x 40mm (3.5" x 1.6").
Digits	Seven 17mm (0.67") and eleven 8mm (0.31") digits. Various symbols and measuring units.
Refresh rate	User definable: fast, 1sec, 3sec, 15sec, 30sec, off.
Option ZB	Transflective LCD with white LED-backlight. Good readings in full sunlight and darkness.
Note ZB	Only available for safe area applications.

### Ambient temperature

Safe areas	-40°C to +80°C (-40°F to +176°F).
Intrinsically Safe	-40°C to +70°C (-40°F to +158°F).

### Power requirements

Type AP	Analog output loop power, 8 - 30V DC. Power consumption max 0.5 Watt.
Type PB	Long life Lithium battery - life-time depends upon settings and configuration - up to 5 years. (requires PD, PL or PX)
Type PC	Intrinsically Safe long life lithium battery - life-time depends upon settings and configuration - up to 5 years. (requires XI and PD or PX)
Type PD	8 - 24V AC / DC ± 10%. Power consumption max. 10 Watt. Intrinsically Safe: 16 - 30V DC; power consumption max. 0.75 Watt.
Type PF	24V AC / DC ± 10%. Power consumption max. 15 Watt.
Type PL	Input loop powered from sensor signal 4 - 20mA (type "A") - requires types AI and OT (not Xi).
Type PM	115 - 230V AC ± 10%. Power consumption max. 15 Watt.
Type PX	8 - 30V DC. Power consumption max. 0.5 Watt.
Type ZB	12 - 24V DC ± 10%. Power consumption max. 1 Watt.
Note PB/PF/PM	Not available Intrinsically Safe.
Note PF/PM	The total consumption of the sensors and outputs may not exceed 400mA @ 24V.
Note	For Intrinsically Safe applications, consult the safety values in the certificate.

### Sensor excitation

Type PB/PC/PX	3.2V DC for pulse signals and 1.2V DC for coil pick-up.
Note	This is not a real sensor supply. Only suitable for sensors with a very low power consumption like coils (sine wave) and reed-switches.
Type PD	1.2 / 3.2 / 8.2 / 12 / 24V DC - max. 50mA @ 24V DC.
Type PD-XI	1.2 / 3.2 / 8.2V DC - max. 7mA @ 8.2V DC and mains power supply voltage (as connected to terminal 1).
Note	In case PD-XI and signal A or U: the sensor supply voltage is according to the power supply voltage connected to terminal 1. Also terminal 2 offers the same voltage.
Type PF / PM	1.2 / 3 / 8.2 / 12 / 24V DC - max. 400mA @ 24V DC.

### Terminal connections

Type	Removable plug-in terminal strip. Wire max. 1.5mm <sup>2</sup> and 2.5mm <sup>2</sup> .
------	---

### Data protection

Type	EEPROM backup of all settings. Backup of running totals every minute. Data retention at least 10 years.
Password	Configuration settings can be password protected.

### Directives & Standards

EMC	Directive 2014/30/EU, FCC 47 CFR part 15.
Low voltage	Directive 2014/35/EU
RoHS	Directive 2011/65/EU
ATEX / IECEx	Directive 2014/34/EU, IEC 600079-0, IEC 60079-11.
IP & NEMA	EN 60529 & NEMA 250

### Enclosure

General	
Window	Polycarbonate window.
Sealing	Silicone.
Control keys	Three industrial micro-switch keys. UV-resistant silicone keypad.

### Aluminum wall / field mount enclosures

General	Die-cast aluminum wall/field mount enclosure IP67 / NEMA Type4X with 2-component UV-resistant coating.
Dimensions	130 x 120 x 75mm (5.12" x 4.72" x 2.95") - W x H x D.
Weight	1100 gr.
Type HA	Cable entry: 2 x PG9 and 1 x M20.
Type HL	Cable entry: 2 x 1/2" NPT.
Type HM	Cable entry: 2 x M16 and 1 x M20.
Type HN	Cable entry: 1 x M20.
Type HO	Cable entry: 2 x M20.
Type HP	Cable entry: 6 x M12.
Type HT	Cable entry: 1 x 1/2" NPT.
Type HU	Cable entry: 3 x 1/2" NPT.
Type HV	Cable entry: 4 x M20.
Type HZ	Cable entry: no holes.

### GRP wall / field mount enclosures

General	GRP wall/field mount enclosure IP67 / NEMA Type4X, UV-resistant and flame retardant.
Dimensions	130 x 120 x 75mm (5.12" x 4.72" x 2.95") - W x H x D.
Weight	600 gr.
Type HD	Cable entry: no holes.
Type HE	Cable entry: 2 x Ø 16mm and 1 x Ø 20mm.
Type HF	Cable entry: 1 x Ø 22mm (7/8").
Type HG	Cable entry: 2 x Ø 20mm.
Type HH	Cable entry: 6 x Ø 12mm.
Type HJ	Cable entry: 3 x Ø 22mm (7/8").
Type HK	Flat bottom, cable entry: no holes.

### Panel mount enclosures

Dimensions	130 x 120 x 60mm (5.12" x 4.72" x 2.36") - W x H x D.
Panel cut-out	115 x 98mm (4.53" x 3.86") L x H.
Type HB	Die-cast aluminum panel mount enclosure IP65 / NEMA Type4X.
Weight	600 gr.
Type HC	GRP panel mount enclosure IP65 / NEMA Type4X, UV-resistant and flame retardant.
Weight	450 gr.

## Hazardous area

### Intrinsically Safe (Type XI)

ATEX certification	 II 1 G Ex ia IIB/IIC T4 Ga. II 1 D Ex ia IIIC T100 °C Da.
IECEX certification	 Ex ia IIC/IIB T4 Ga. Ex ia IIIC T100 °C Da.
Ambient Ta	-40°C to +70°C (-40°F to +158°F).

### Explosion proof (Type XF)

ATEX certification	 II 2 G Ex d IIB T5 Gb. II 2 G x t IIIB T100 °C Db.
Type XF	Dimensions of enclosure: 300 x 250 x 200mm (11.8" x 9.9" x 7.9") L x H x D.
Weight	Appr. 15kg.
Note	IECEX available on request.

## Signal inputs

### Flow meter

Type P	Coil / sine wave (HI: 20mVpp or LO: 80mVpp - sensitivity selectable), NPN/PNP, open collector, reed-switch, Namur, active pulse signals 8 - 12 and 24V DC.
Frequency	Minimum 0Hz - maximum 7kHz for total and flow rate. Maximum frequency depends on signal type and internal low-pass filter. E.g. reed switch with low-pass filter: max. frequency 120Hz.
K-Factor	0.000010 - 9,999,999 with variable decimal position.
Low-pass filter	Available for all pulse signals.
Option ZF	coil sensitivity 10mVpp.
Type A	(0)4 - 20mA. Analog input signal can be scaled to any desired range within 0 - 20mA.
Type U	0 - 10V DC. Analog input signal can be scaled to any desired range within 0 - 10V DC.
Accuracy	Resolution: 14 bit. Error < 0.025mA / ± 0.125% FS. Low level cut-off programmable.
Span	0.000010 - 9,999,999 with variable decimal position.
Update time	Four times per second.
Voltage drop	Type A: 2.5V @ 20mA.
Load impedance	Type U: 3kOhm.
Relationship	Linear and square root calculation.
Note	For signal type A and U: external power to sensor is required; e.g. type PD.

### Additional input

Function	<ul style="list-style-type: none"> <li>Terminal input to reset total remotely.</li> <li>If this terminal input is closed, the "clear total"-function is disabled.</li> </ul>
Type IB	Internally pulled-up switch contact - NPN.
Duration	Minimum pulse duration 100msec.

## Signal outputs

### Communication option

Function	Reading display information, reading / writing all configuration settings.
Protocol	Modbus RTU.
Speed	1200 - 2400 - 4800 - 9600 baud.
Addressing	Maximum 255 addresses.
Type CB	RS232
Type CH	RS485 2-wire
Type CI	RS485 4-wire
Type CT	TTL Intrinsically Safe.

## Analog output

Function	Transmitting linearized flow rate.
Accuracy	10 bit. Error < 0.05%. Analog output signal can be scaled to any desired range.
Update time	Eight times per second.
Type AA	Active 4 - 20mA output (requires PD, PF, PM or PX).
Type AB	Active 0 - 20mA output (requires PD, PF, PM or PX).
Type AF	Passive floating 4 - 20mA output for Intrinsically Safe applications (requires XI + PD or PX).
Type AI	Passive galvanically isolated 4 - 20mA output - also available for battery powered models.
Type AP	Passive 4 - 20mA output - not isolated. Unit will be loop powered.
Type AU	Active 0 - 10V DC output (requires PD, PF, PM or PX).

## Digital output

Function	Pulse output - transmitting accumulated total.
Frequency	Max. 500Hz. Pulse length user definable between 0.001 second up to 9.999 seconds.
Type OA	One active 24V DC transistor output (PNP); max. 50mA per output (requires PD, PF, PM or PX).
Type OR	One electro-mechanical relay output - isolated; max. switch power 230V AC (N.O.) - 0.5A per relay (requires PF or PM).
Type OT	One passive transistor output (NPN) - not isolated. Max. 50V DC - 300mA per output.

## Operational

### Operator functions

Displayed Functions	<ul style="list-style-type: none"> <li>Linearized flow rate and / or total.</li> <li>Linearized total and accumulated total.</li> <li>Total can be reset to zero by pressing the CLEAR-key twice.</li> </ul>
---------------------	--

### Total

Digits	7 digits.
Units	L, m <sup>3</sup> , GAL, USGAL, kg, lb, bbl, no unit.
Decimals	0 - 1 - 2 or 3.
Note	Total can be reset to zero.

### Accumulated total

Digits	11 digits.
Units / decimals	According to selection for total.
Note	Can not be reset to zero.

### Flow rate

Digits	7 digits.
Units	mL, L, m <sup>3</sup> , Gallons, kg, Ton, lb, bl, cf, RND, ft <sup>3</sup> , scf, Nm <sup>3</sup> , NL, igal - no units.
Decimals	0 - 1 - 2 or 3.
Time units	/sec - /min - /hr - /day.



## Ordering information

Standard configuration: F112-P-AP-CX-HC-IX-OT-PX-XX-ZX.



### Ordering information:

F112 - -A -C -H -I -O -P -X -Z



#### Flow meter input signal

- A  (0)4 - 20mA input.
- P  **Pulse input: coil, npn, pnp, namur, reed-switch.**
- U  0 - 10V DC input.



#### Analog output signal

- AA Active 4 - 20mA output - requires PD, PF, PM or PX.
- AB Active 0 - 20mA output - requires PD, PF, PM or PX.
- AF  I.S. floating 4 - 20mA output - requires XI + PD or PX.
- AI Isolated 4 - 20mA output
- AP  **Passive 4 - 20mA output, loop powered unit.**
- AU Active 0 - 10V DC output - requires PD, PF, PM or PX.







#### Communication

- CB Communication RS232 - Modbus RTU.
- CH Communication RS485 - 2-wire - Modbus RTU.
- CI Communication RS485 - 4-wire - Modbus RTU.
- CT  Intrinsically Safe TTL - Modbus RTU.
- CX  **No communication.**











#### Panel mount enclosures - IP65 / NEMA Type4X

- HB  Aluminum enclosure.
- HC  **GRP enclosure.**



#### GRP field / wall mount enclosures - IP67 / NEMA Type4X

- HD  Cable entry: no holes.
- HE  Cable entry: 2 x Ø 16mm & 1 x Ø 20mm.
- HF  Cable entry: 1 x Ø 22mm (7/8").
- HG  Cable entry: 2 x Ø 20mm.
- HH  Cable entry: 6 x Ø 12mm.
- HJ  Cable entry: 3 x Ø 22mm (7/8").
- HK  Flat bottom, cable entry: no holes.

#### Aluminum field / wall mount enclosures - IP67 / NEMA Type4X

- HA  Cable entry: 2 x PG9 + 1 x M20.
- HL  Cable entry: 2 x 1/2"NPT.
- HM  Cable entry: 2 x M16 + 1 x M20.
- HN  Cable entry: 1 x M20.
- HO  Cable entry: 2 x M20.
- HP  Cable entry: 6 x M12.
- HT  Cable entry: 1 x 1/2"NPT.
- HU  Cable entry: 3 x 1/2"NPT.
- HV  Cable entry: 4 x M20.
- HZ  Cable entry: no holes.



#### Additional input signal

- IB  Remote control input to reset total or to lock the "clear total" button.
- IX  **No additional input.**

#### Digital output signal

- OA One active transistor output - requires PD, PF, PM or PX.
- OR One mechanical relay output - requires PF or PM.
- OT  **One passive transistor output - standard configuration.**

#### Power requirements

- PD  8 - 24V AC/DC + sensor supply - with XI: 16 - 30V DC.
- PF 24V AC/DC + sensor supply.
- PL Input loop powered from sensor signal type "A" - requires AI and OT (not XI).
- PM 115 - 230V AC + sensor supply.
- PX  **Basic power supply 8 - 30V DC (no real sensor supply).**



#### Additional battery supply (optional)

- PB Lithium battery powered - requires PD, PL or PX.
- PC  Lithium battery powered - Intrinsically Safe - requires XI, and PD or PX.

#### Hazardous area

- XI  Intrinsically Safe, according ATEX and IECEx.
- XF Ex d enclosure - 3 keys according ATEX.
- XX **Safe area only.**

#### Other options

- ZB Backlight.
- ZF  Coil input 10mVpp.
- ZX  **No options.**

The bold marked text contains the standard configuration.

 Available Intrinsically Safe.

Specifications are subject to change without notice.



Quality  
ISO 9001

www.dekra-seal.com

Fluidwell bv  
P.O. Box 6  
5460 AA - Veghel - The Netherlands  
Telephone: +31 (0)413 343 786  
Telefax: +31 (0)413 363 443  
email: displays@fluidwell.com  
Internet: www.fluidwell.com

