

# BATCH CONTROLLER

WITH TWO STAGE CONTROL / PULSE OUTPUT



## Features

- Large display shows preset value and running batch value simultaneously.
- Self-learning overrun correction.
- Easy operation to enter a batch value and to control the process.
- Count-up and count-down function available.
- Selectable on-screen engineering units; volumetric or mass.
- Ability to process all types of flowmeter signals.
- Operational temperature -40°C up to +80°C (-40°F up to 176°F).
- Very compact design for panel mount, wall mount or field mount applications.
- Rugged aluminum field mount enclosure IP67/NEMA4X.
- Intrinsically Safe - ATEX and IECEx approval for gas and dust applications.
- Explosion/flame proof  II 2 GD EEx d IIB T5.
- Full Modbus communication RS232/485/TTL.
- Loop or battery powered, 8 - 24V AC/DC or 115 - 230V AC power supply.
- Sensor supply 3.2 / 8.2 / 12 / 24V DC.
- No-flow monitoring.

## Signal output

- Two configurable control outputs: for two-stage or one-stage control.
- Scaled pulse output according to accumulated total (one stage control only).

## Signal input

### Flow

- Reed-switch.
- NAMUR.
- NPN/PNP pulse.
- Sine wave (coil).
- Active pulse signals.
- (0)4 - 20mA.
- 0 - 10V DC.

### Status

- Remote control: start.
- Remote control: pause / stop.

## Applications

- For batching small up to very large quantities. Single or repeating batches. Alternative basic model: F030 or more sophisticated models: F131, F136 and 300 series

## General information

### Introduction

The F130 is a straight forward two-stage Batch controller offering exactly what is required for many applications. The operator can enter a batch quantity easily or execute repeating batches. During the batch, the preset value is displayed as well as the batched (or remaining) quantity and the units of measurement. The automatic self-learning overrun correction ensures an accurate result after each batch. A wide selection of options further enhances the capabilities of this model, which includes Intrinsic Safety and full Modbus communication.

### Display

The display has large 17mm (0.67") and 8mm (0.31") digits which show the batched quantity and the preset value simultaneously. On-screen engineering units are easily configured from a comprehensive menu.

A seven digit resettable "day total" is available as well as an eleven digit non-resettable accumulated total. All values are backed-up in EEPROM memory every minute.

### Configuration

All configuration settings are accessed via a simple operator menu which can be pass-code protected. Each setting is clearly indicated with an alphanumeric description, which avoids confusing abbreviations and baffling codes. Once familiar with one F-series product, you will be able to program all models in the series without a manual. All settings are safely stored in EEPROM memory in the event of sudden power failure.

### Control outputs

Two outputs are available which can be configured to operate as two stage control for large batch quantities or as one stage control for smaller batches. In this case, the second output is available as a scaled pulse output according to accumulated total or batch total. The pulse output length is user defined from 0.008 second up to 2 seconds. The maximum output frequency is 64Hz. The output signals can be passive NPN, active PNP or isolated electro-mechanical relays.

### Signal input

The F130 will accept most pulse and analog input signals for volumetric flow or mass flow measurement. For remote control, two inputs are available to start, pause and stop the batch process.

### No-flow

If there is a predefined time-out in the input signal, the no-flow alarm will be triggered. The F130 goes in pause-mode and the display will show: NO FLOW.

### Communication

All process data and settings can be read and modified manually or through the Modbus communication link (RS232 / RS485). If desired, the batch process can even be started and stopped through communication.

### Hazardous areas

This model has been ATEX and IECEx certified Intrinsically Safe for gas and dust applications, with an allowed operational temperature of -40°C to +70°C (-40°F to +158°F).

A flame proof enclosure with ATEX certification offers the rating  $\text{Ex}$  II 2 GD EEx d IIB T5.

### Enclosures

All enclosures are ATEX and IECEx approved. As standard the F130 is supplied in an GRP panel mount enclosure, which can be converted to an IP67 / NEMA 4X GRP field mount enclosure by the addition of a back case. Most popular is our rugged aluminum field mount enclosure.

## Overview application F130

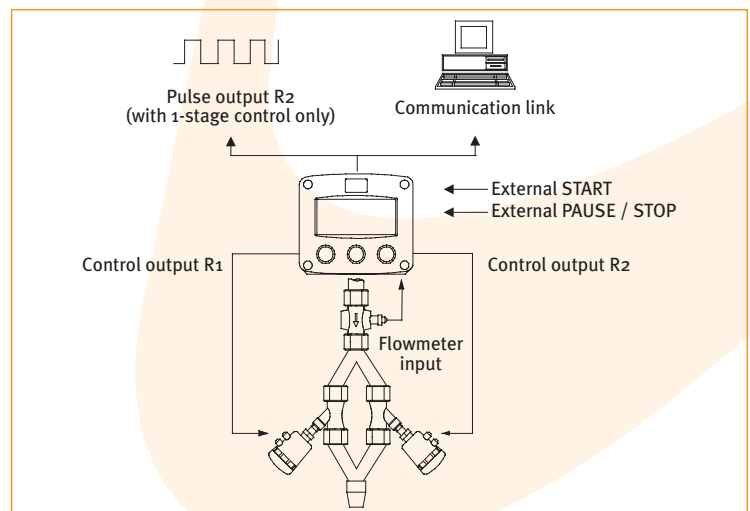



Typical wiring diagram F130-P-CH-OT-PB-(PX)

Typical wiring diagram F130-P-CH-OT-PX

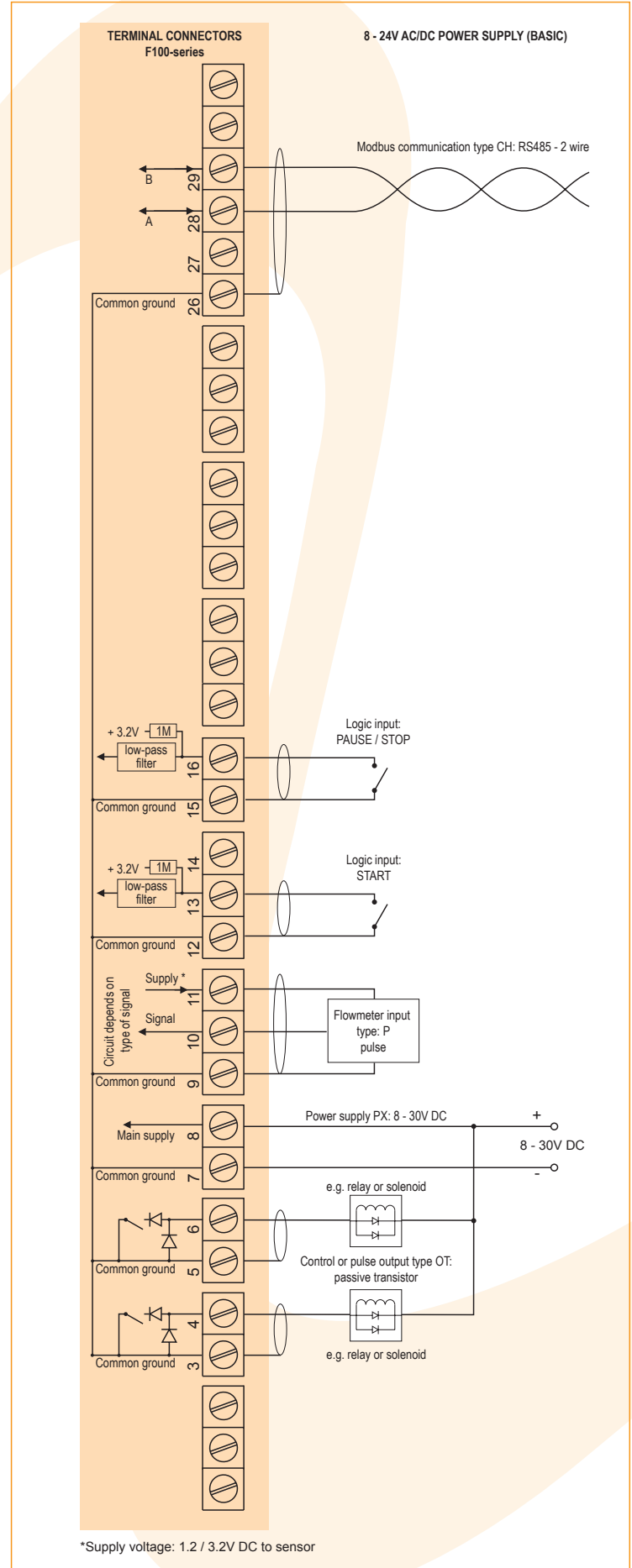
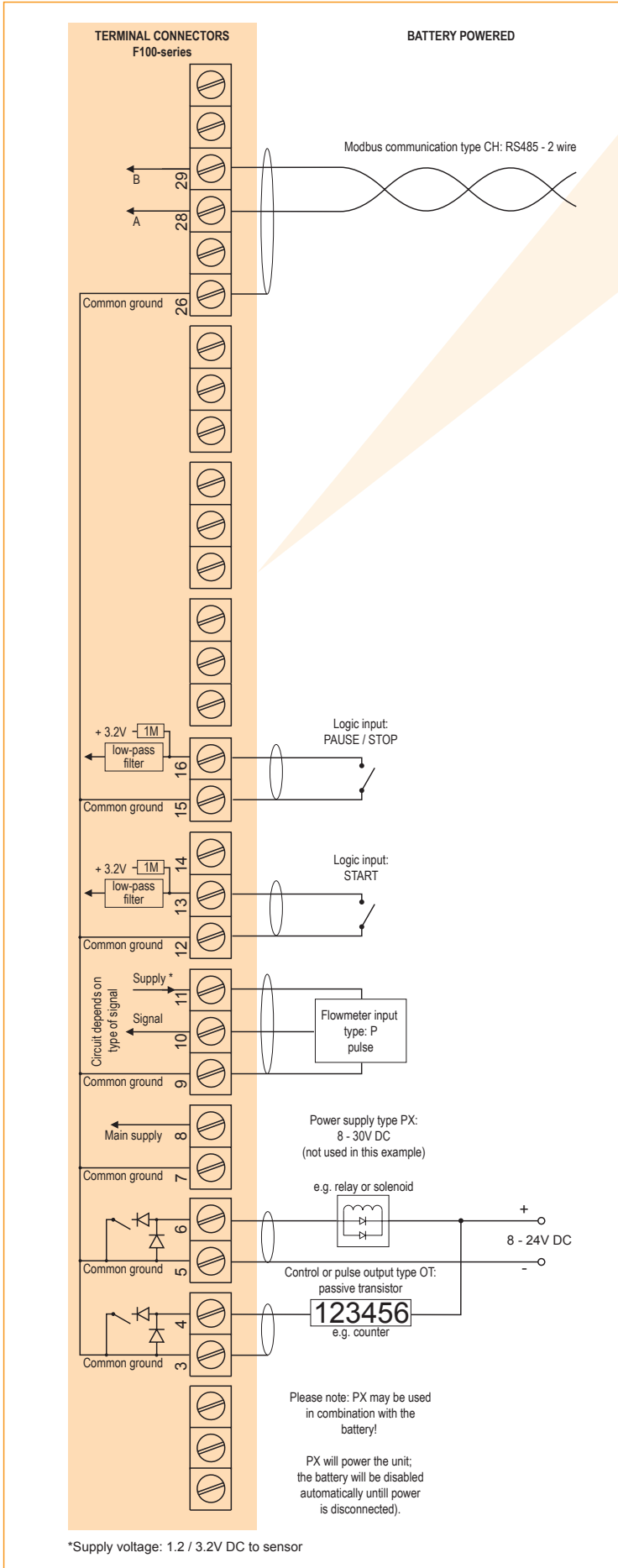

Typical wiring diagram F130-A-CB-OA-PD

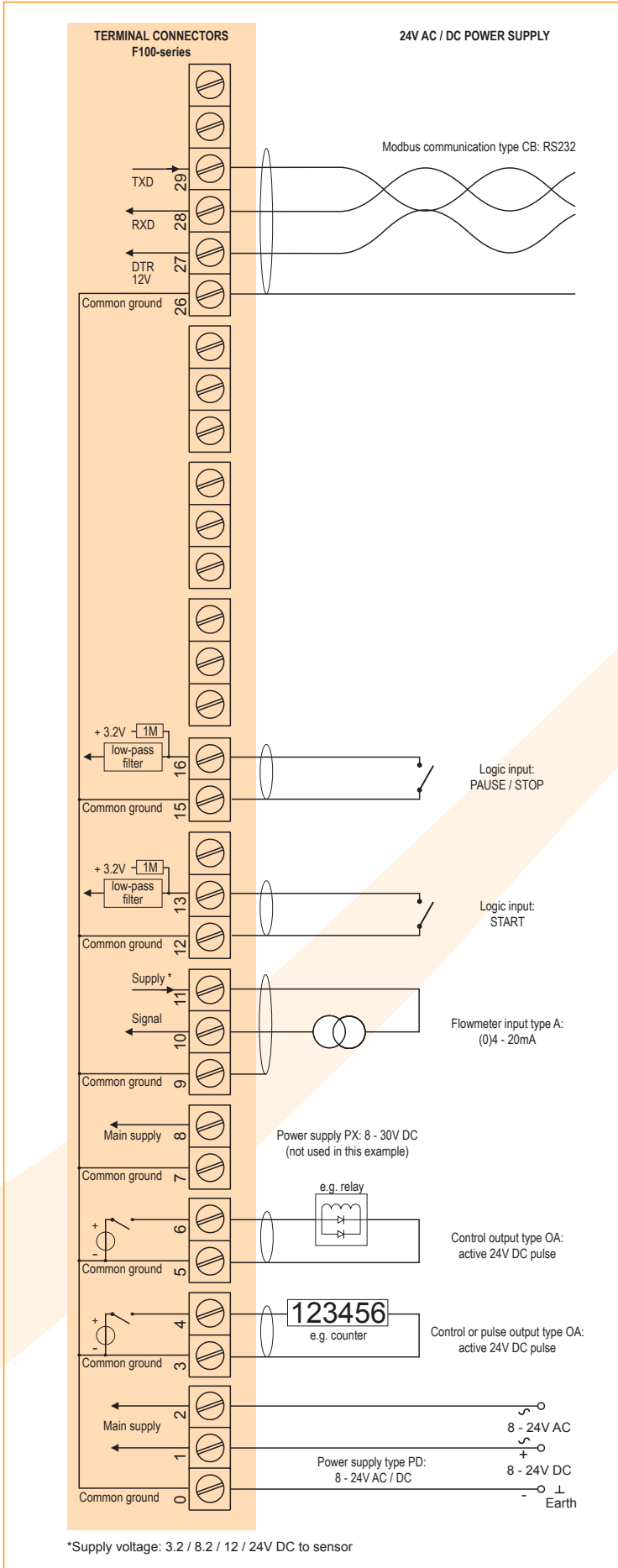

Typical wiring diagram F130-A-CI-OR-PM

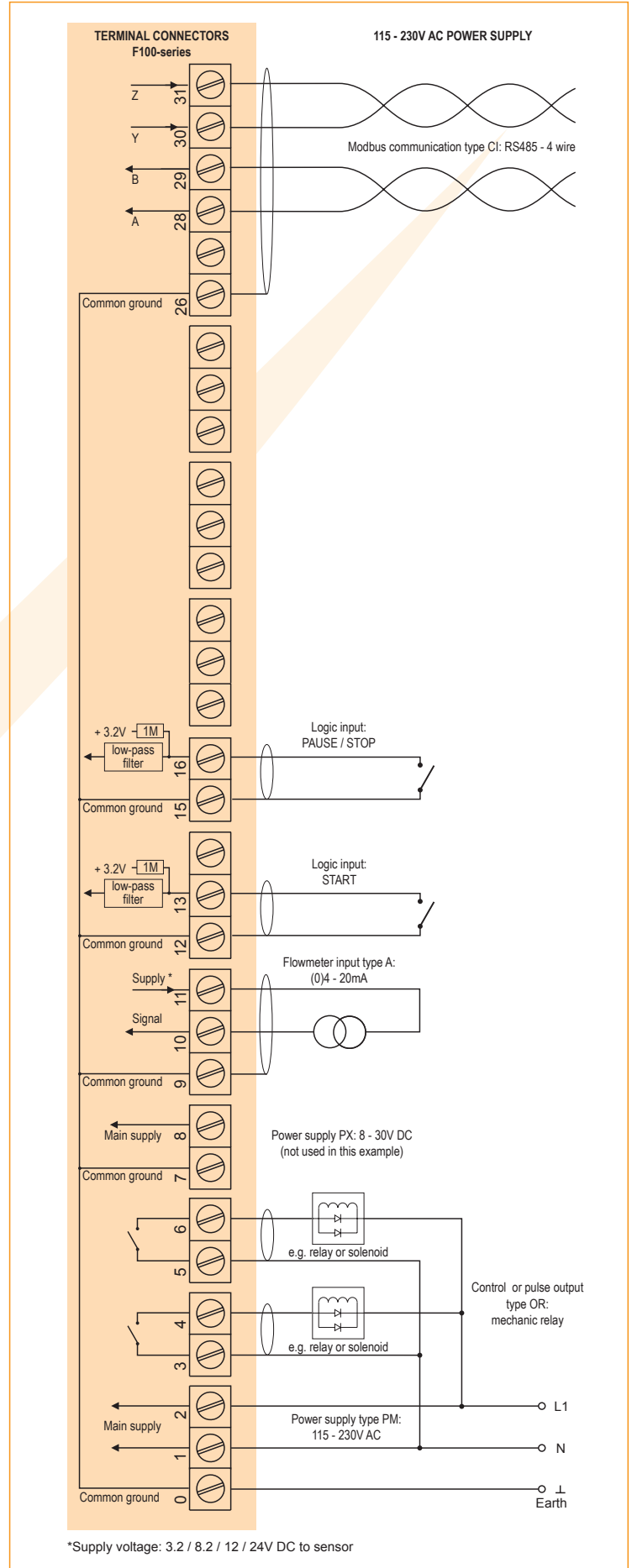

## Hazardous area applications

The F130-XI has been certified according ATEX and IECEx by DEKRA for use in Intrinsically Safe applications with an ambient temperature of -40°C to +70°C (-40°F to +158°F).

- The ATEX markings for gas and dust applications are:

**Ex II 1 G Ex ia IIB/IIC T4 Ga**  
**II 1 D Ex ia IIIC T100 C Da IP6X.**

- The IECEx markings for gas and dust applications are: **Ex ia IIC/IIB T4 Ga** and **Ex ia IIIC T100 C Da IP6X.**

Besides the I.S. power supplies for the control outputs, it is allowed to connect up to two I.S. power supplies in IIB / IIIC applications or one in IIC applications. Consult the certificate for the maximum input and output values of the circuits. Full functionality of the F130 remains available, including two stage control, pulse output and Modbus communication (type CT). Power supply type PD-XI offers a 8.2V sensor supply e.g. for one Namur sensor. A flame proof enclosure with rating ATEX **Ex II 2 GD EEx d IIB T5** is available as well. Please contact your supplier for further details.

## Certificate of conformity KEMA 03ATEX1074 X

- IECEx DEK 11.0042X

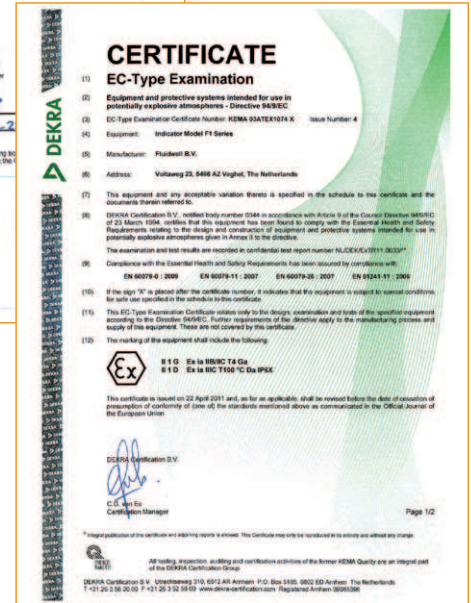

## Configuration example IIB / IIIC and IIC - F130-P-OT-PC-(PX)-XI - Battery powered unit

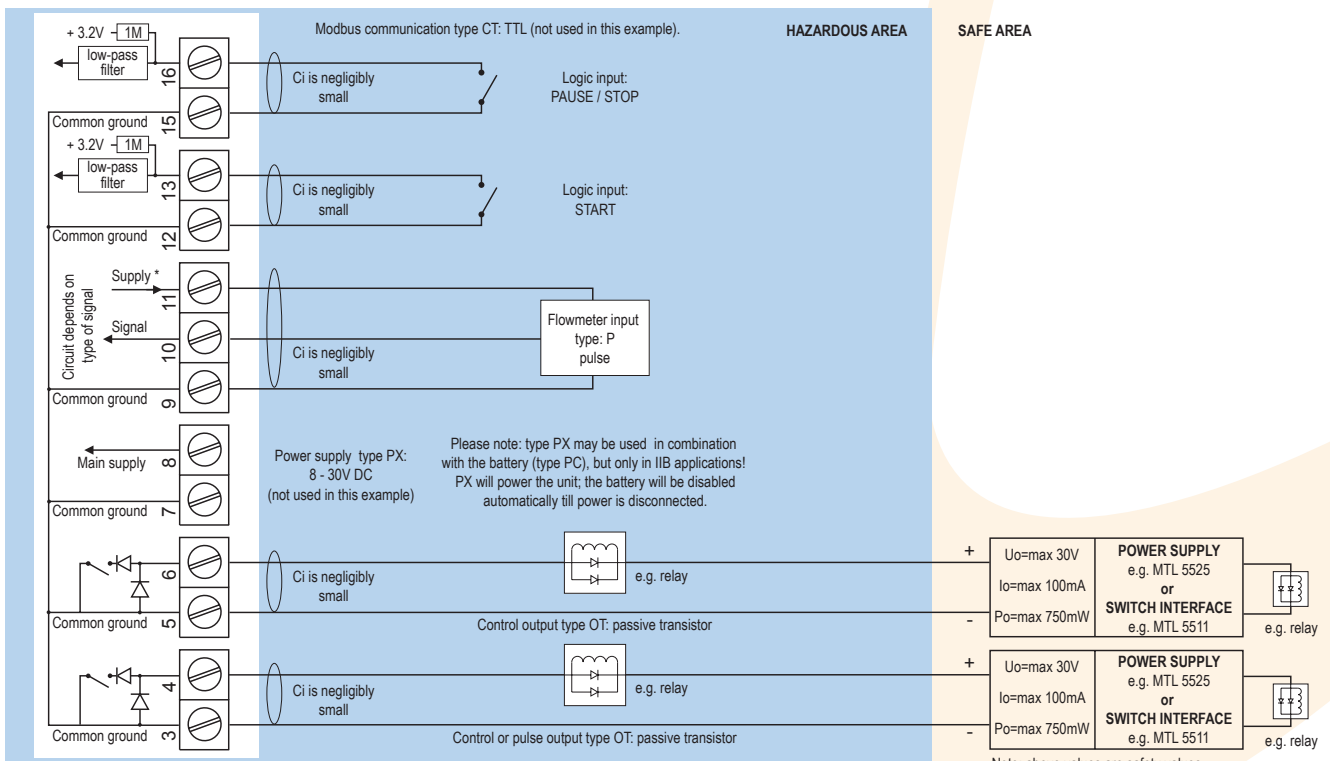

\* Note sensor supply voltage: 1.2V DC for coil sensors or 3.2V DC for other pulse sensors.

Note: above values are safety values. Consult the technical specification for operational values.

Configuration example IIB / IIIC and IIC - F130-P-(CT)-OT-PX-XI - Basic power supply 8 - 30V DC

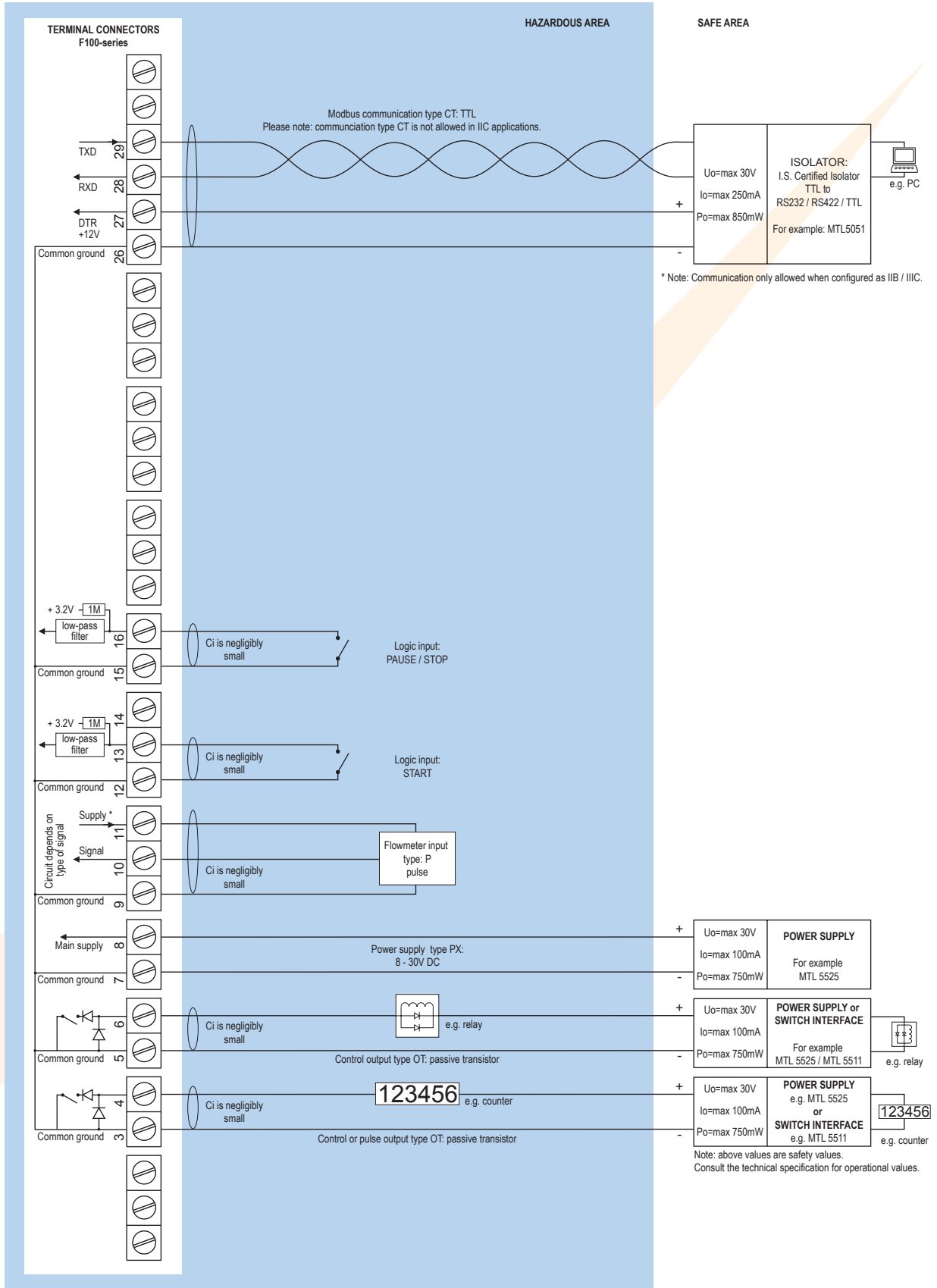

\* Note sensor supply voltage: 1.2V DC for coil sensors or 3.2V DC for other pulse sensors.

## Configuration example IIB / IIIC and IIC - F130-A-CT-OT-PC-XI - Battery powered unit

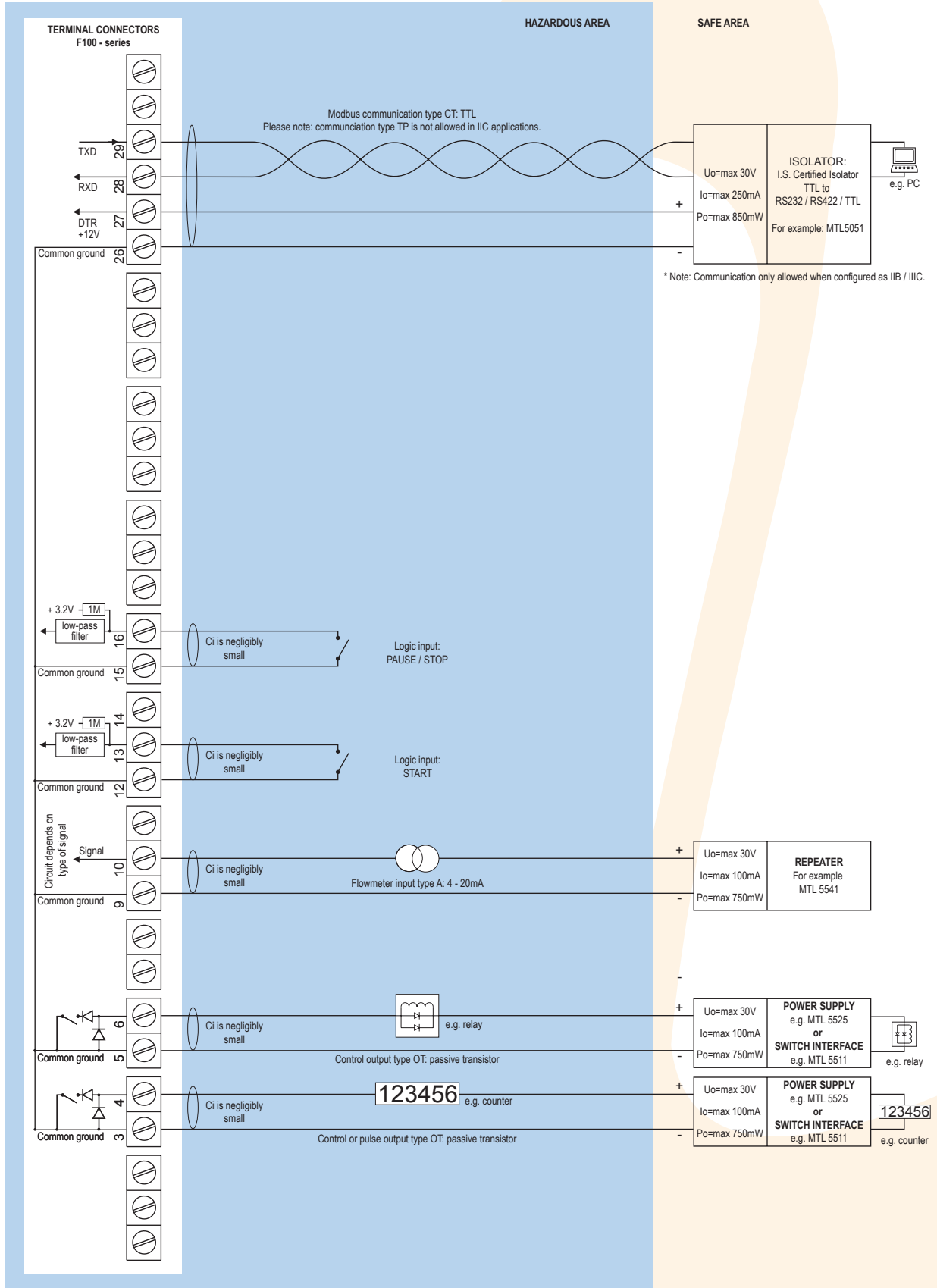



## Configuration example IIB / IIC and IIC - F130-A-(CT)-OT-PD-XI - Power supply 16 - 30V DC

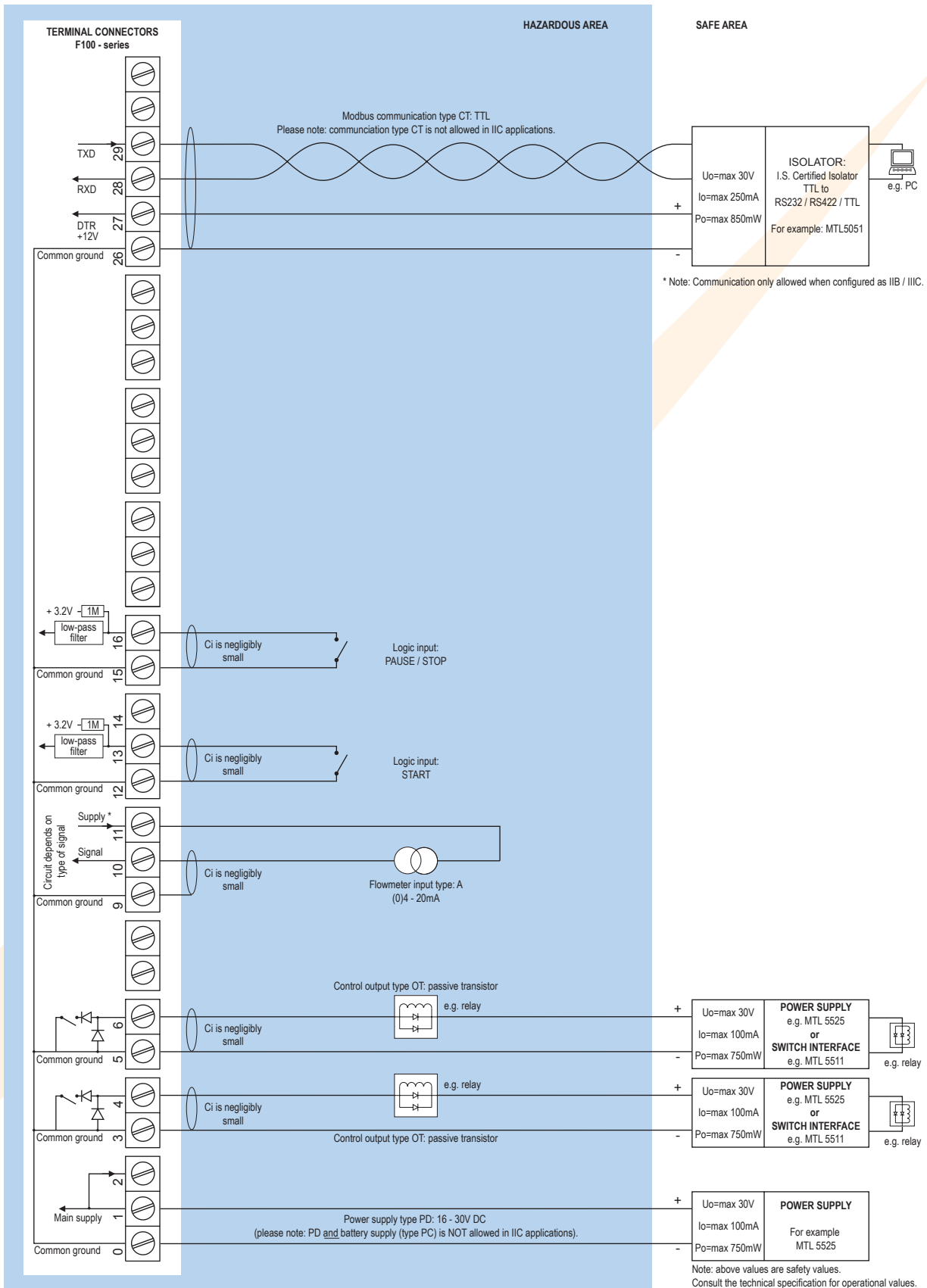

\* Note power supply type PD: the supply voltage to pulse sensors is maximum 8.7V (U<sub>o</sub>=max 8.7V I<sub>o</sub>=max 25mA P<sub>o</sub>=max 150mW) and to analog sensors as connected to terminal 1 (internally linked).

## Technical specification

### General

Display	
Type	High intensity reflective numeric and alphanumeric LCD, UV-resistant.
Dimensions	90 x 40mm (3.5" x 1.6").
Digits	Seven 17mm (0.67") and eleven 8mm (0.31") digits. Various symbols and measuring units.
Refresh rate	User definable: 8 times/sec. - 1 time/30 secs.
Option ZB	Transflective LCD with green LED backlight. Good readings in full sunlight and darkness.
Note ZB	Only available for safe area applications.

### Operating temperature

Standard unit	-40°C to +80°C (-40°F to +176°F).
Intrinsically Safe	-40°C to +70°C (-40°F to +158°F).

### Power requirements

Type PB	Long life Lithium battery - life-time depends upon settings and configuration - up to 5 years.
Type PC	Intrinsically Safe long life lithium battery - life-time depends upon settings and configuration - up to 5 years.
Type PD	8 - 24V AC / DC ± 10%. Power consumption max. 10 Watt. Intrinsically Safe: 16 - 30V DC; power consumption max. 0.75 Watt.
Type PF	24V AC / DC ± 10%. Power consumption max. 15 Watt.
Type PL	Input loop powered from sensor signal 4 - 20mA (type "A") - requires type OT (not Xi).
Type PM	115 - 230V AC ± 10%. Power consumption max. 15 Watt.
Type PX	8 - 30V DC. Power consumption max. 0.5 Watt.
Type ZB	12 - 24V DC ± 10% or internally powered with type PD / PF / PM. Power consumption max. 1 Watt.
Note PB/PF/PM	Not available Intrinsically Safe.
Note PF/PM	The total consumption of the sensors and outputs may not exceed 400mA @ 24V.
Note	For Intrinsically Safe applications, consult the safety values in the certificate.

### Sensor excitation

Type PB/PC/PX	3.2V DC for pulse signals and 1.2V DC for coil pick-up.
Note	This is not a real sensor supply. Only suitable for sensors with a very low power consumption like coils (sine wave) and reed-switches.
Type PD	1.2 / 3.2 / 8.2 / 12 / 24V DC - max. 50mA @ 24V DC.
Type PD-XI	1.2 / 3.2 / 8.2V DC - max. 7mA @ 8.2V DC and mains power supply voltage (as connected to terminal 1).
Note	In case PD-XI and signal A or U: the sensor supply voltage is according to the power supply voltage connected to terminal 1. Also terminal 2 offers the same voltage.
Type PF / PM	1.2 / 3.2 / 8.2 / 12 / 24V DC - max. 400mA @ 24V DC.

### Terminal connections

Type	Removable plug-in terminal strip. Wire max. 1.5mm <sup>2</sup> and 2.5mm <sup>2</sup> .
------	---

### Data protection

Type	EEPROM backup of all settings. Backup of running totals every minute. Data retention at least 10 years.
Pass-code	Configuration settings can be pass-code protected.

### Casing

#### General

Window	Polycarbonate window.
Sealing	Silicone.
Control keys	Three industrial micro-switch keys. UV-resistant silicone keypad.

#### Aluminum wall / field mount enclosures

General	Die-cast aluminum wall/field mount enclosure IP67 / NEMA 4X with 2-component UV-resistant coating.
Dimensions	130 x 120 x 75mm (5.12" x 4.72" x 2.95") - W x H x D.
Weight	1100 gr.
Type HA	Cable entry: 2 x PG9 and 1 x M20.
Type HM	Cable entry: 2 x M16 and 1 x M20.
Type HN	Cable entry: 1 x M20.
Type HO	Cable entry: 2 x M20.
Type HP	Cable entry: 6 x M12.
Type HT	Cable entry: 1 x 1/2" NPT.
Type HU	Cable entry: 3 x 1/2" NPT.
Type HV	Cable entry: 4 x M20.
Type HZ	Cable entry: no holes.

#### GRP wall / field mount enclosures

General	GRP wall/field mount enclosure IP67 / NEMA 4X, UV-resistant and flame retardant.
Dimensions	130 x 120 x 75mm (5.12" x 4.72" x 2.95") - W x H x D.
Weight	600 gr.
Type HD	Cable entry: no holes.
Type HE	Cable entry: 2 x Ø 16mm and 1 x Ø 20mm.
Type HF	Cable entry: 1 x Ø 22mm (7/8").
Type HG	Cable entry: 2 x Ø 20mm.
Type HH	Cable entry: 6 x Ø 12mm.
Type HJ	Cable entry: 3 x Ø 22mm (7/8").
Type HK	Flat bottom, cable entry: no holes.

#### Panel mount enclosures



Dimensions	130 x 120 x 60mm (5.12" x 4.72" x 2.36") - W x H x D.
Panel cut-out	115 x 98mm (4.53" x 3.86") L x H.
Type HB	Die-cast aluminum panel mount enclosure IP65 / NEMA 4X.
Weight	600 gr.
Type HC	GRP panel mount enclosure IP65 / NEMA 4X, UV-resistant and flame retardant.
Weight	450 gr.

#### ABS wall / field mount enclosures

General	Silicone free ABS wall/field mount enclosure IP65 with EPDM and PE sealings. UV-resistant polyester keypad (old HD enclosure).
Dimensions	130 x 114 x 71mm (5.1" x 4.5" x 2.8") - W x H x D.
Weight	450 gr.
Type HS	Cable entry: no holes.

### Hazardous area

#### Intrinsically Safe (Type XI)

ATEX certification	 II 1 G Ex ia IIB/IIC T4 Ga. II 1 D Ex ia IIIC T100 °C Da IP6X.
IECEx certification	 Ex ia IIC/IIB T4 Ga. Ex ia IIIC T100 °C Da IP6X.
Ambient Ta	-40°C to +70°C (-40°F to +158°F).

### Explosion proof (Type XF)

ATEX certification	Ex II 2 GD EEx d IIB T5.
Dimensions	300 x 250 x 200mm (11.8" x 9.9" x 7.9") L x H x D.
Weight	Appr. 15kg.

### Environment

Electromagnetic compatibility	Compliant ref: EN 61326 (1997), EN 61010-1 (1993).
-------------------------------	--

### Signal inputs

#### Flowmeter

Type P	Coil / sine wave (minimum 20mVpp or 80mVpp - sensitivity selectable), NPN/PNP, open collector, reed-switch, Namur, active pulse signals 8 - 12 and 24V DC.
Frequency	Minimum 0Hz - maximum 7kHz for total and flow rate. Maximum frequency depends on signal type and internal low-pass filter. E.g. reed switch with low-pass filter: max. frequency 120Hz.
K-Factor	0.000010 - 9,999,999 with variable decimal position.
Low-pass filter	Available for all pulse signals.
Option ZF	coil sensitivity 10mVpp.
Type A	(0)4 - 20mA. Analog input signal can be scaled to any desired range within 0 - 20mA.
Type U	0 - 10V DC. Analog input signal can be scaled to any desired range within 0 - 10V DC.
Accuracy	Resolution: 14 bit. Error < 0.025mA / $\pm$ 0.125% FS. Low level cut-off programmable.
Span	0.000010 - 9,999,999 with variable decimal position.
Update time	Four times per second.
Voltage drop	Type A: 2.5V @ 20mA.
Load impedance	Type U: 3k $\Omega$ .
Relationship	Linear and square root calculation.
Note	For signal type A and U: external power to sensor is required; e.g. type PD.

### Logic inputs

Function	Two terminal inputs to start, pause and stop the batch process.
Type	Internally pulled-up switch contact - NPN.
Duration	Minimum pulse duration 100msec.

### Signal outputs

#### Control / pulse output

Function	User defined: batch process one or two stage control - scaled pulse output according the running batch or according accumulated total (one stage only).
Frequency	Max. 64Hz. Pulse length user definable between 7.8 msec up to 2 seconds.
Type OA	Two active 24V DC transistor outputs (PNP); max. 50mA per output (requires PD, PF or PM).
Type OR	Two electro-mechanical relay outputs (N.O.) - isolated; max. switch power 230V AC - 0.5A per relay (requires PF or PM).
Type OT	Two passive transistor outputs (NPN) - not isolated. Max. 50V DC - 300mA per output.

### Communication option

Function	Reading display information, reading / writing preset value and all configuration settings. Start, pause and stop batch process
Protocol	Modbus ASCII / RTU.
Speed	1200 - 2400 - 4800 - 9600 baud.
Addressing	Maximum 255 addresses.
Type CB	RS232
Type CH	RS485 2-wire
Type CI	RS485 4-wire
Type CT	TTL Intrinsically Safe.

### Operational

#### Operator functions

Displayed functions	<ul style="list-style-type: none"><li>• Preset value - can be entered by the operator.</li><li>• Batched quantity or remaining quantity.</li><li>• Total and accumulated total.</li><li>• Total can be reset to zero by pressing the STOP-key twice.</li><li>• No-flow alarm.</li></ul>
---------------------	---

#### Preset and total

Digits	7 digits.
Units	L, m <sup>3</sup> , GAL, USGAL, kg, lb, bbl, no unit.
Decimals	0 - 1 - 2 or 3.
Note	Total can be reset to zero.

#### Accumulated total

Digits	11 digits.
Units / decimals	According to selection for total.
Note	Can not be reset to zero.

### Accessories

#### Mounting accessories

ACF02	Stainless steel wall mounting kit.
ACF05	Stainless steel pipe mounting kit (worm gear clamps not included).
ACF06	Two stainless steel worm gear clamps $\varnothing$ 44 - 56mm.
ACF07	Two stainless steel worm gear clamps $\varnothing$ 58 - 75mm.
ACF08	Two stainless steel worm gear clamps $\varnothing$ 77 - 95mm.
ACF09	Two stainless steel worm gear clamps $\varnothing$ 106 - 138mm.
ACF10	Customized Grevopal tagplates for ACF02 and ACF05, including stainless steel screws. Dimension: 95mm x 12.5mm (3.75" x 0.50").

#### Cable gland accessories

ACF20	For HA enclosure, includes O-rings.
ACF25	For HE enclosure, includes locknuts and O-rings.
ACF26	For HF enclosure, includes locknuts and O-rings.
ACF27	For HG enclosure, includes locknuts and O-rings.
ACF28	For HH enclosure, includes locknuts and O-rings.
ACF29	For HJ enclosure, includes locknuts and O-rings.
ACF32	For HM enclosure, includes O-rings.
ACF33	For HN enclosure, includes O-rings.
ACF34	For HO enclosure, includes O-rings.
ACF35	For HP enclosure, includes O-rings.
ACF39	For HT enclosure, includes O-rings.
ACF40	For HU enclosure, includes O-rings.

## Ordering information

Standard configuration: F130-P-AX-CX-EX-HC-IX-OT-PX-TX-XX-ZX.

Ordering information: F130 \_ -AX -C \_ -EX -H \_ -IX -O \_ -P \_ -TX -X \_ -Z \_

### Flowmeter input signal

- A  (0)4 - 20mA input.
- P  **Pulse input: coil, npn, pnp, namur, reed-switch.**
- U  0 - 10V DC input.

### Analog output signal

- AX  **No analog output.**

### Communication

- CB Communication RS232 - Modbus ASCII / RTU.
- CH Communication RS485 - 2-wire - Modbus ASCII / RTU.
- CI Communication RS485 - 4-wire - Modbus ASCII / RTU.
- CT  Intrinsically Safe TTL - Modbus ASCII / RTU.
- CX  **No communication.**

### Flow equations

- EX  **No flow equations.**

### Panel mount enclosures - IP65 / NEMA4X

- HB  Aluminum enclosure.
- HC  **GRP enclosure.**

### GRP field / wall mount enclosures - IP67 / NEMA4X

- HD  Cable entry: no holes.
- HE  Cable entry: 2 x Ø 16mm & 1 x Ø 20mm.
- HF  Cable entry: 1 x Ø 22mm (7/8").
- HG  Cable entry: 2 x Ø 20mm.
- HH  Cable entry: 6 x Ø 12mm.
- HJ  Cable entry: 3 x Ø 22mm (7/8").
- HK  Flat bottom, cable entry: no holes.

### Aluminum field / wall mount enclosures - IP67 / NEMA4X

- HA  Cable entry: 2 x PG9 + 1 x M20.
- HM  Cable entry: 2 x M16 + 1 x M20.
- HN  Cable entry: 1 x M20.
- HO  Cable entry: 2 x M20.
- HP  Cable entry: 6 x M12.
- HT  Cable entry: 1 x 1/2" NPT.
- HU  Cable entry: 3 x 1/2" NPT.
- HV  Cable entry: 4 x M20.
- HZ  Cable entry: no holes.

### ABS field / wall mount enclosures - IP65

- HS  Silicone free ABS field enclosure - Cable entry: no holes (old HD enclosure).

### Additional inputs

- IX  **No additional input.**

### Outputs

- OA Two active transistor outputs - requires PD, PF or PM.
- OR Two mechanical relay outputs - requires PF or PM.
- OT  **Two passive transistor outputs - standard configuration.**

### Power supply

- PB Lithium battery powered.
- PC  Lithium battery powered - Intrinsically Safe.
- PD  8 - 24V AC/DC + sensor supply - with XI: 16 - 30V DC.
- PF 24V AC/DC + sensor supply.
- PL Input loop powered from sensor signal type "A" (not Xi).
- PM 115 - 230V AC + sensor supply.
- PX  **Basic power supply 8 - 30V DC (no real sensor supply).**

### Temperature input signal

- TX  **No temperature input signal.**

### Hazardous area

- XI  Intrinsically Safe, according ATEX and IECEx.
- XF EExd enclosure - 3 keys.
- XX **Safe area only.**

### Other options

- ZB Backlight.
- ZF  Coil input 10mVpp.
- ZX  **No options.**

The bold marked text contains the standard configuration.

Available Intrinsically Safe.

