

# BATCH CONTROLLER

WITH TWO STAGE CONTROL  
AND RECEIPT PRINTER DRIVER



## Features

- Receipt printing function after each batch.
- Large display shows preset value and running batch value simultaneously.
- Easy operation to enter a batch value, print an extra receipt and to control the process.
- Count-up and count-down function available.
- Self-learning overrun correction.
- No-flow monitoring.
- Selectable on-screen engineering units; volumetric or mass.
- Operational temperature -40°C up to +80°C (-40°F up to 176°F).
- Very compact design for panel mount, wall mount or field mount applications.
- Rugged aluminum field mount enclosure IP67/NEMA4X.
- Intrinsically Safe - ATEX and IECEx approval for gas and dust applications.
- Explosion/flame proof  II 2 GD EEx d IIB T5.
- Lithium battery powered, 8 - 24V AC/DC or 115 - 230V AC power supply.
- Sensor supply 3.2 / 8.2 / 12 / 24V DC.

## Signal output

- Two configurable control outputs: for two-stage or one-stage control.

## Signal input

### Flow

- Reed-switch.
- NAMUR.
- NPN/PNP pulse.
- Sine wave (coil).
- Active pulse signals.

### Status

- Remote control: start.
- Remote control: pause / stop.

## Applications

- Batching of small and / or large quantities, single or repeating batches where printed information is requested. Alternative basic model: F030 or more sophisticated models: F130, F131, F136 and 0300 series.

## General information

### Introduction

The F132 is a straight forward two stage batch controller with the unique function to send a “print receipt” command to a printer after every batch. The operator can easily enter a batch quantity, send an extra “print receipt” command or execute repeating batches. During the batch, the preset value is displayed as well as the batched (or remaining) quantity including the units of measurement. The automatic self-learning overrun correction ensures an accurate result after each batch. A wide selection of options further enhances the capabilities of this model, which includes Intrinsic Safety.

### Display

The display has large 17mm (0.67”) and 8mm (0.31”) digits which show the batched quantity and the preset value simultaneously. On-screen engineering units are easily configured from a comprehensive menu.

A seven digit resettable “day total” is available as well as an eleven digit non-resettable accumulated total. All values are backed-up in EEPROM memory every minute.

### Configuration

All configuration settings are accessed via a simple operator menu which can be pass-code protected. Each setting is clearly indicated with an alphanumeric description, which avoids confusing abbreviations and baffling codes. Once familiar with one F-series product, you will be able to program all models in the series without a manual. All settings are safely stored in EEPROM memory in the event of sudden power failure.

### Control outputs

Two outputs are available which can be configured to operate as two stage control for large batch quantities or as one stage control for smaller batches. The output signals can be passive NPN, active PNP or isolated electro-mechanical relays.

### Signal input

The F132 accepts most pulse input signals for volumetric flow or mass flow measurement.

For remote control, two inputs are available to start, pause and stop the batch process.

### No-flow

If there is a predefined time-out in the input signal, the no-flow alarm will be triggered.

The F132 goes in pause-mode and the display will show: NO FLOW.

### Printer communication

The “print receipt” command is processed through the ASCII data communication link (RS232 / RS485). Receipt printing functionality remains available for the Intrinsically Safe version (TTL).

### Hazardous areas

This model has been ATEX and IECEx certified Intrinsically Safe for gas and dust applications, with an allowed operational temperature of -40°C to +70°C (-40°F to +158°F).

A flame proof enclosure with ATEX certification offers the rating  $\text{Ex}$  II 2 GD EEx d IIB T5.

### Enclosures

All enclosures are ATEX and IECEx approved. As standard the F132 is supplied in an GRP panel mount enclosure, which can be converted to an IP67 / NEMA 4X GRP field mount enclosure by the addition of a back case. Most popular is our rugged aluminum field mount enclosure.

## Overview application F132

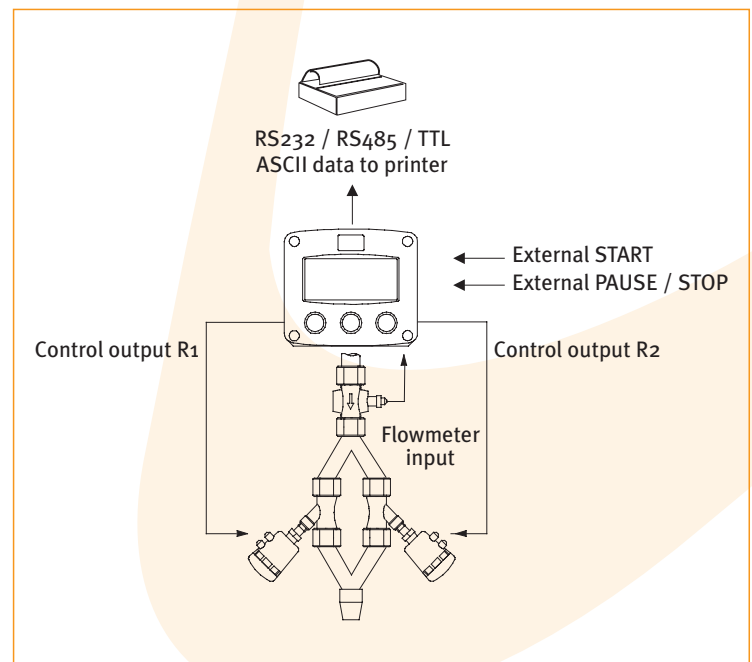

## Dimensions enclosures

### Aluminum & GRP panel mount enclosure

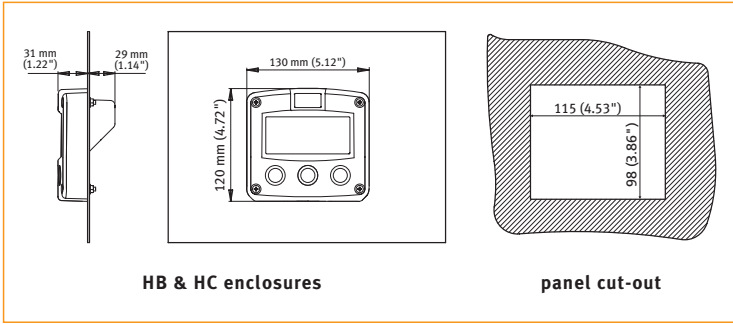

### Aluminum & GRP field / wall mount enclosures

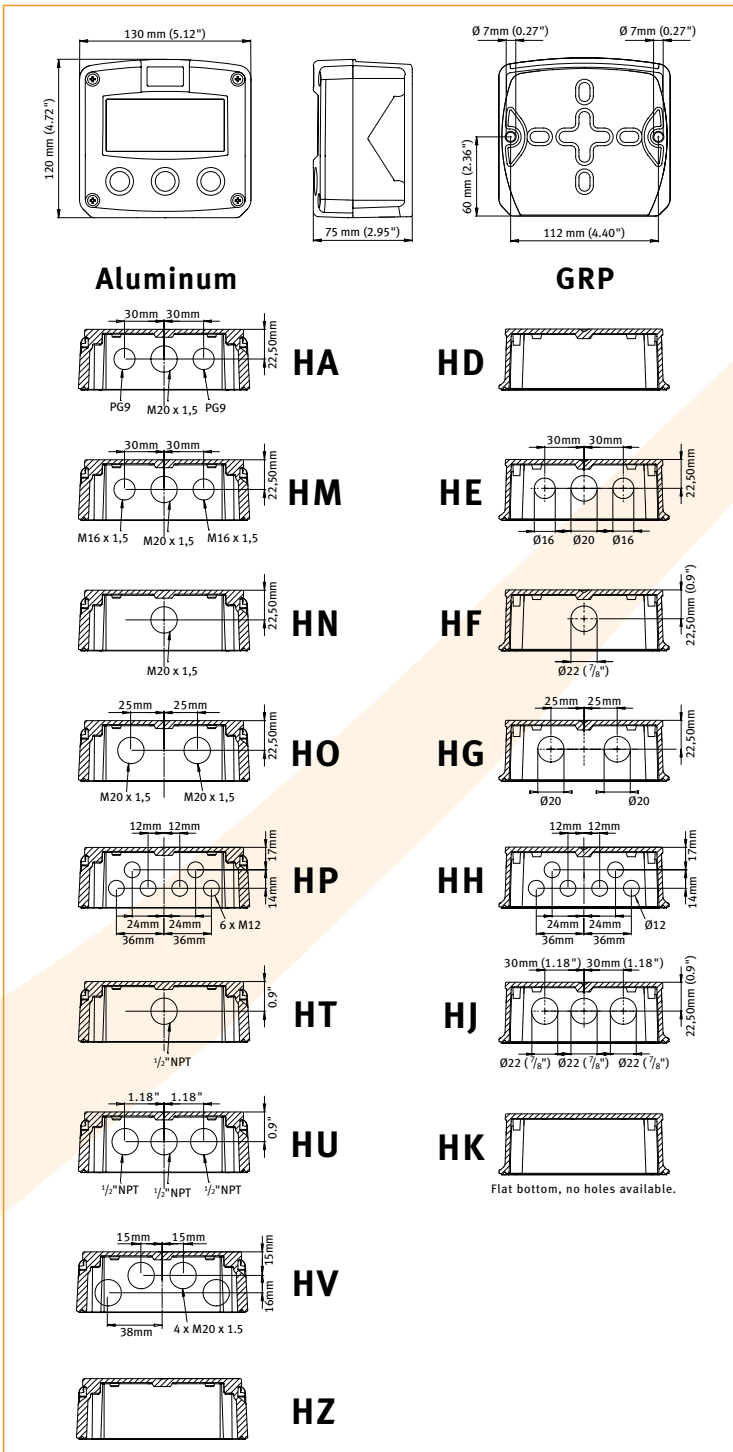

## Terminal connections

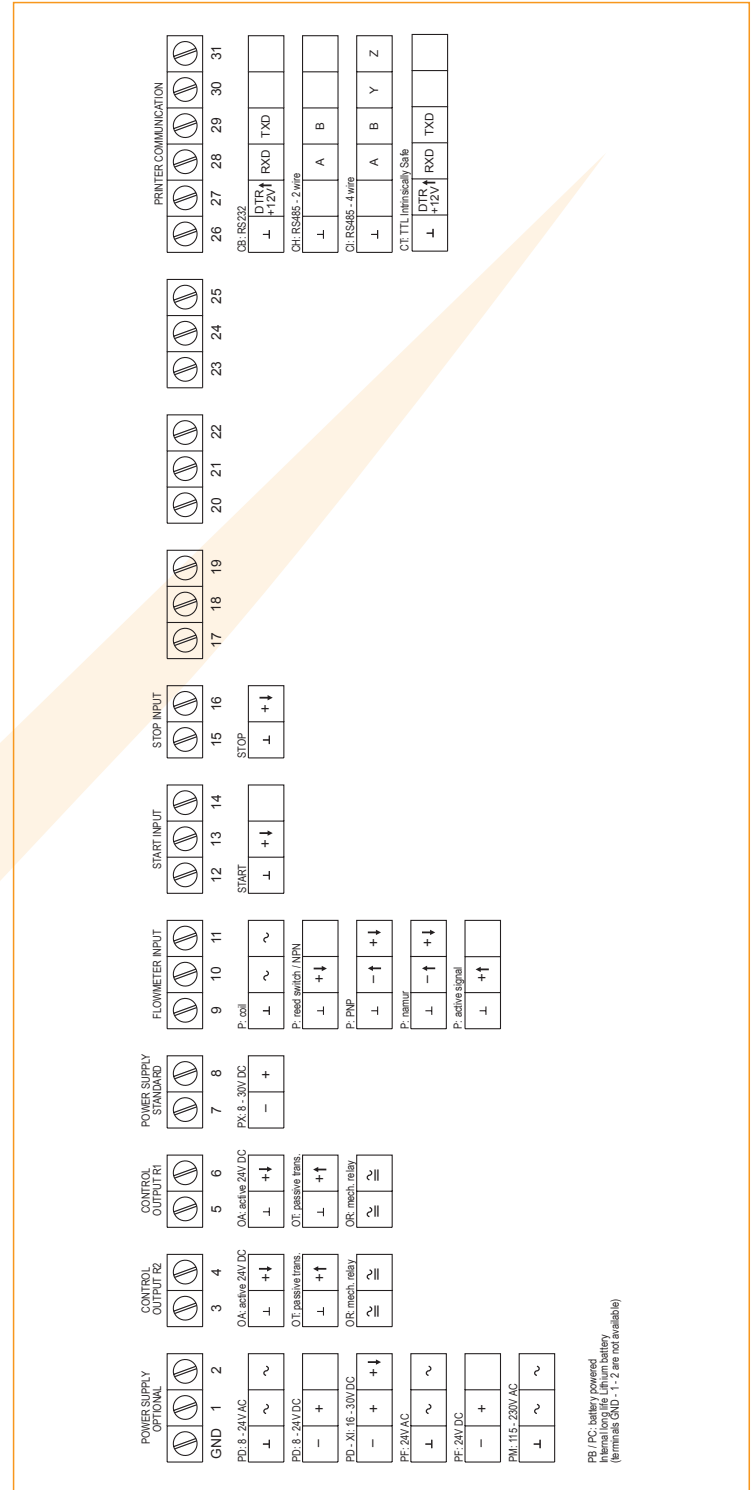

### Display example - 90 x 40mm (3.5" x 1.6")

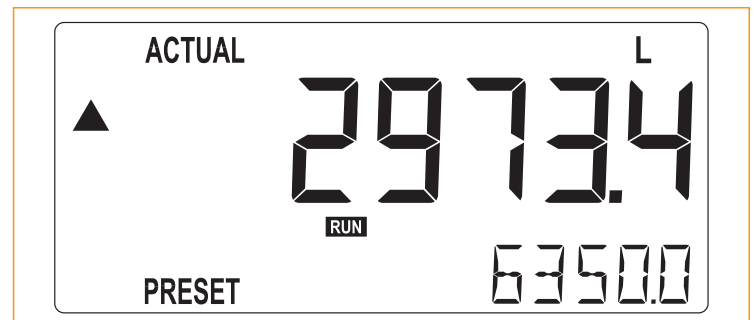

Typical wiring diagram F132-P-CH-OT-PB-(PX)

Typical wiring diagram F132-P-CH-OT-PX

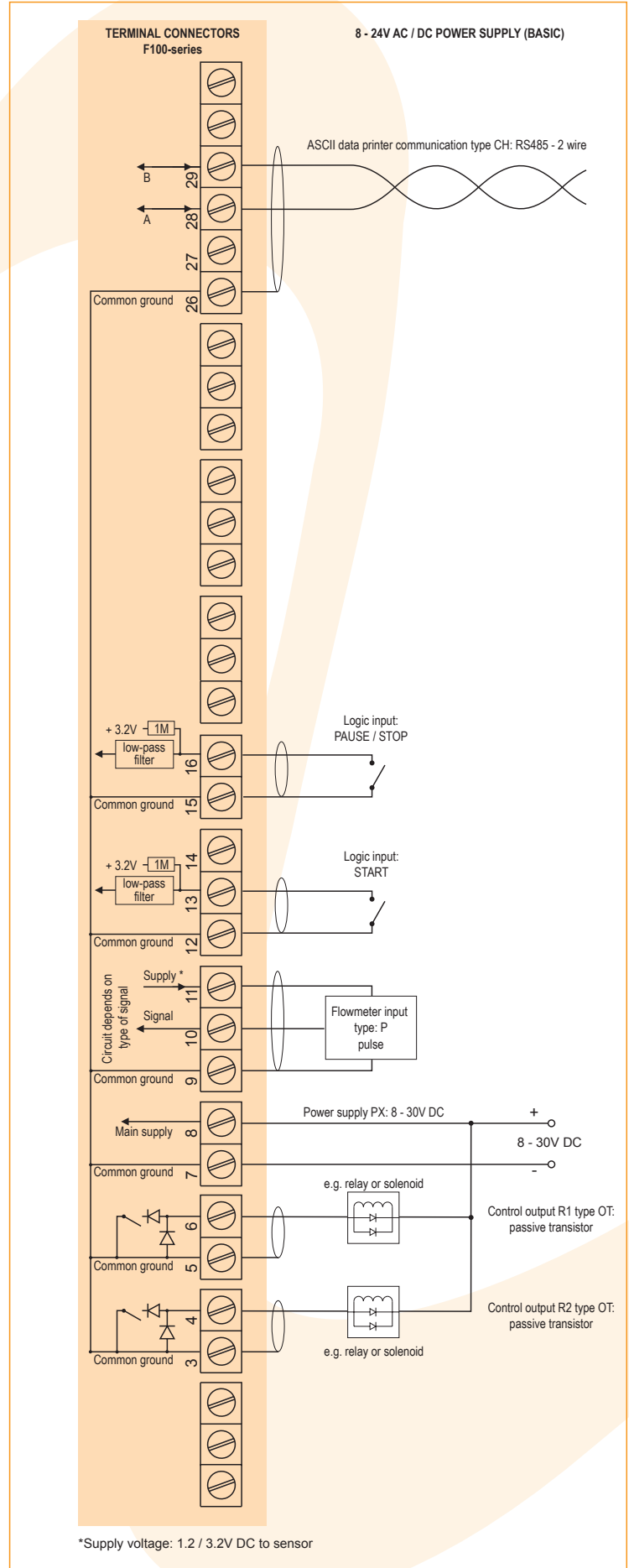
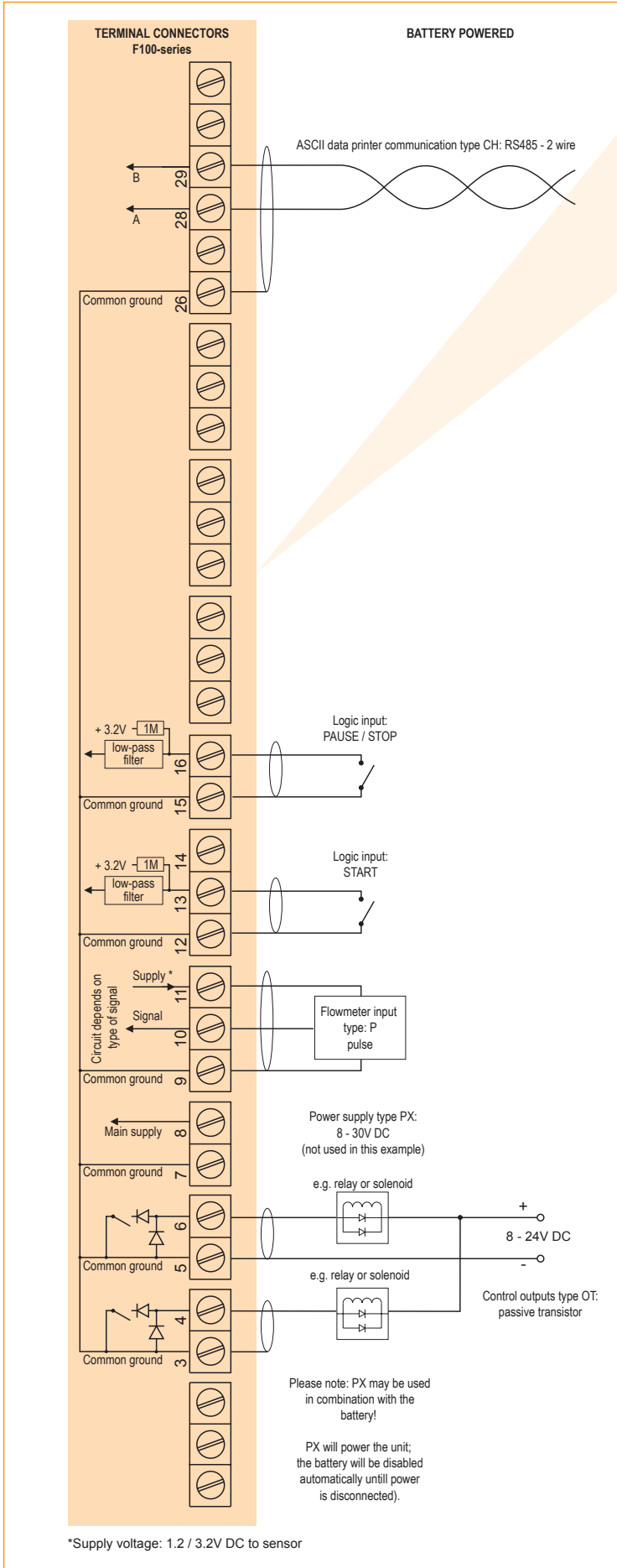

Typical wiring diagram F132-P-CB-OA-PD

Typical wiring diagram F132-P-CI-OR-PM

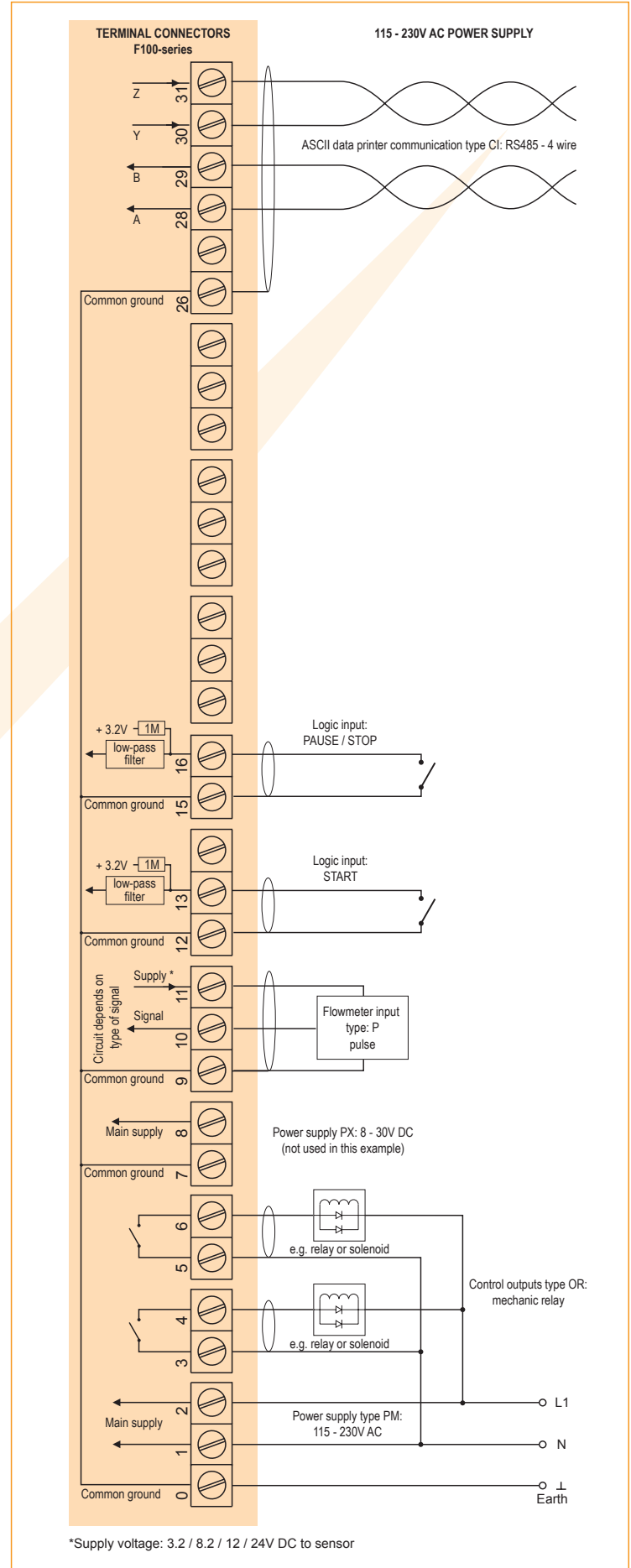
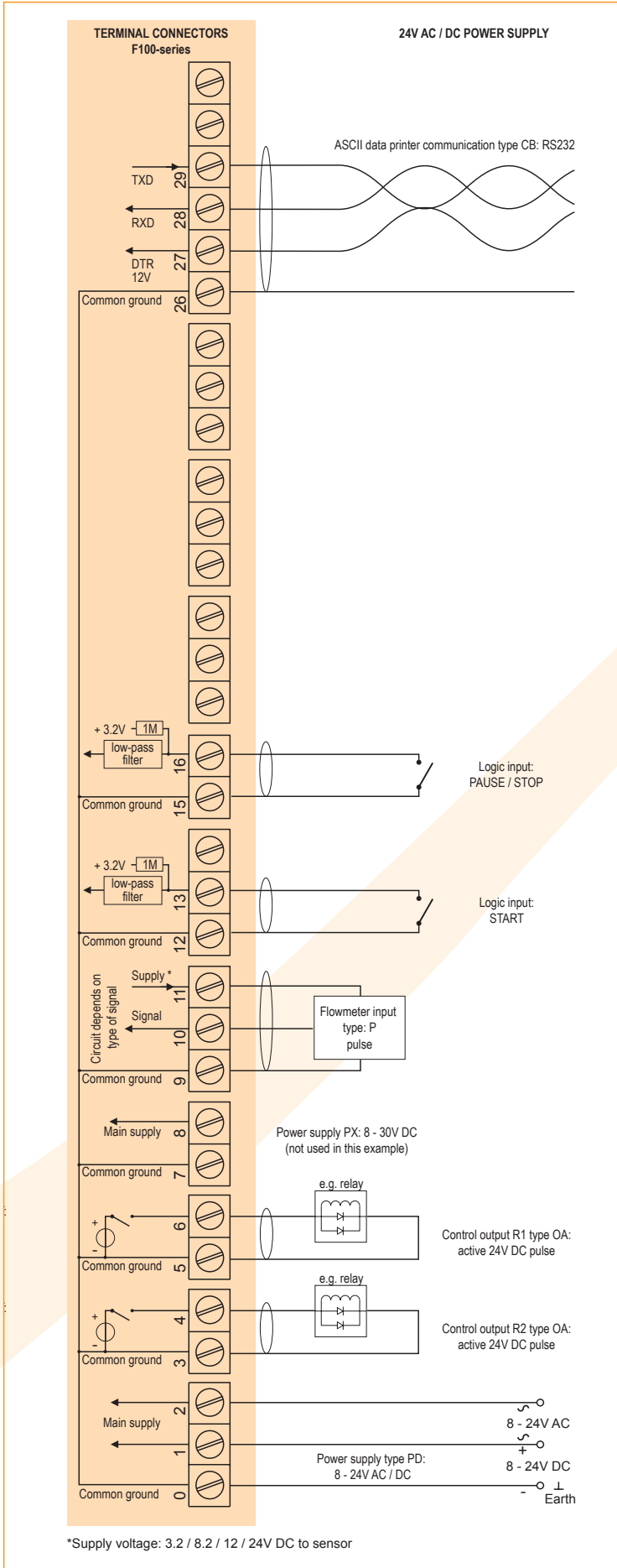

## Hazardous area applications

The F132-XI has been certified according ATEX and IECEx by DEKRA for use in Intrinsically Safe applications with an ambient temperature of -40°C to +70°C (-40°F to +158°F).

- The ATEX markings for gas and dust applications are:

**II 1 G Ex ia IIB/IIC T4 Ga**  
**II 1 D Ex ia IIIC T100 C Da IP6X.**

- The IECEx markings for gas and dust applications are: **Ex ia IIC/IIB T4 Ga** and **Ex ia IIIC T100 C Da IP6X.**

Besides the I.S. power supplies for the control outputs, it is allowed to connect up to two I.S. power supplies in IIB/IIIC applications or one in IIC applications. Consult the certificate for the maximum input and output values of the circuits.

Full functionality of the F132 remains available, including two stage control and Modbus communication (type CT).

Power supply type PD-XI offers a 8.2V sensor supply e.g. for one Namur sensor.

A flame proof enclosure with rating ATEX **II 2 GD EEx d IIB T5** is available as well.

Please contact your supplier for further details.

## Certificate of conformity KEMA 03ATEX1074 X • IECEx DEK 11.0042X

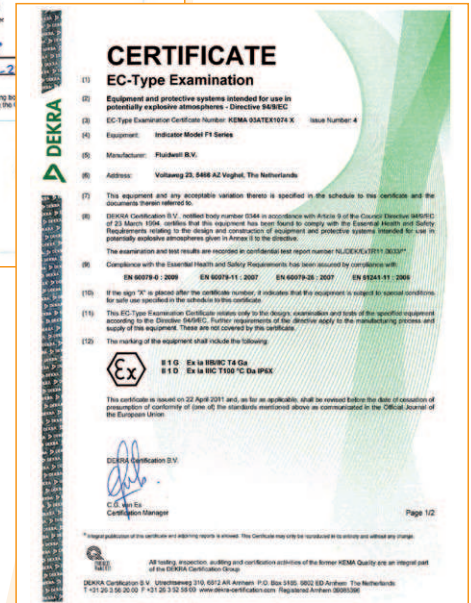

## Configuration example IIB / IIIC and IIC - F132-P-(CT)-OT-PX-XI - Battery powered unit

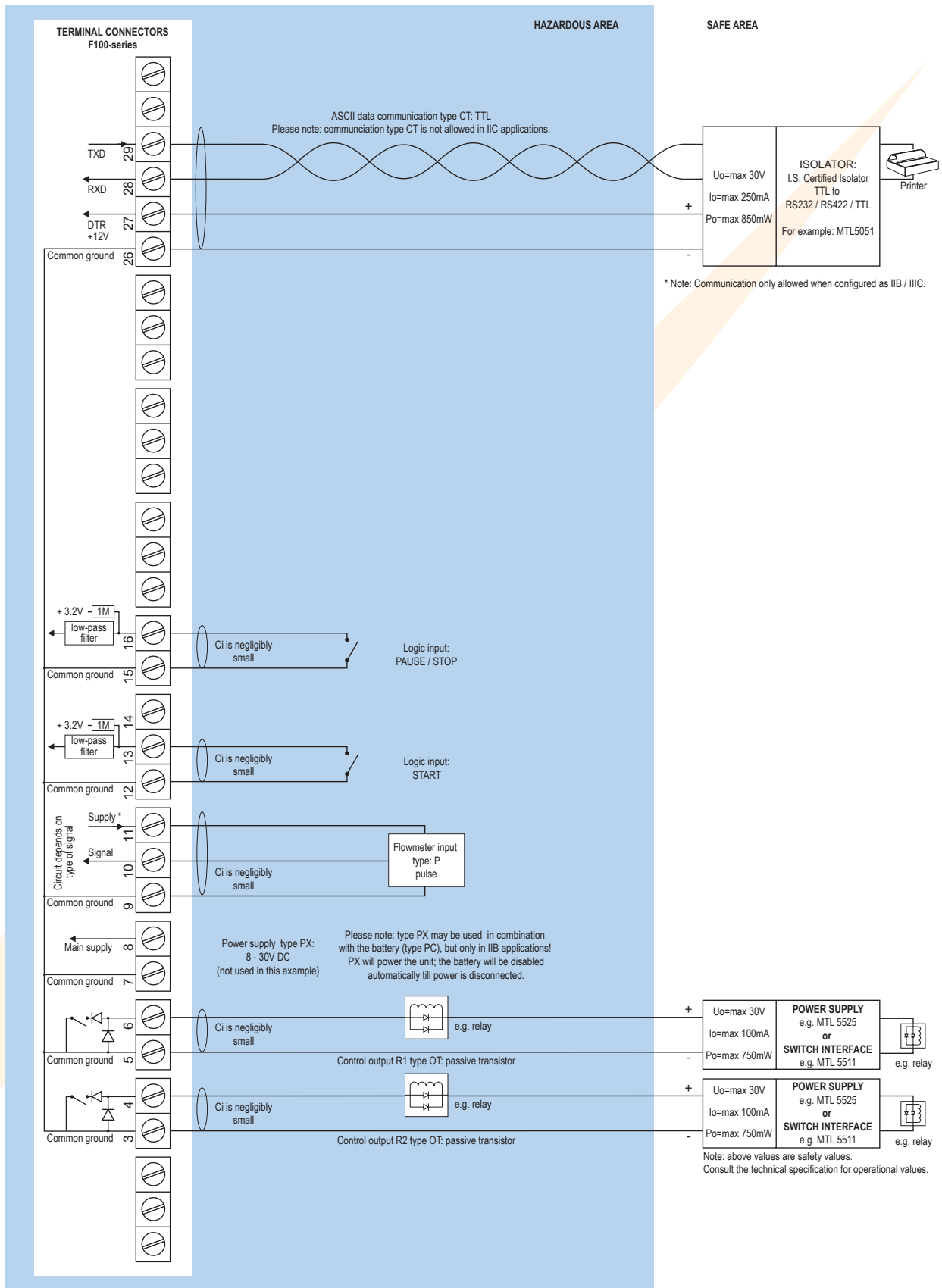

\* Note sensor supply voltage: 1.2V DC for coil sensors or 3.2V DC for other pulse sensors.

Configuration example IIB / IIIC and IIC - F132-P-(CT)-OT-PX-XI - Basic power supply 8 - 30V DC

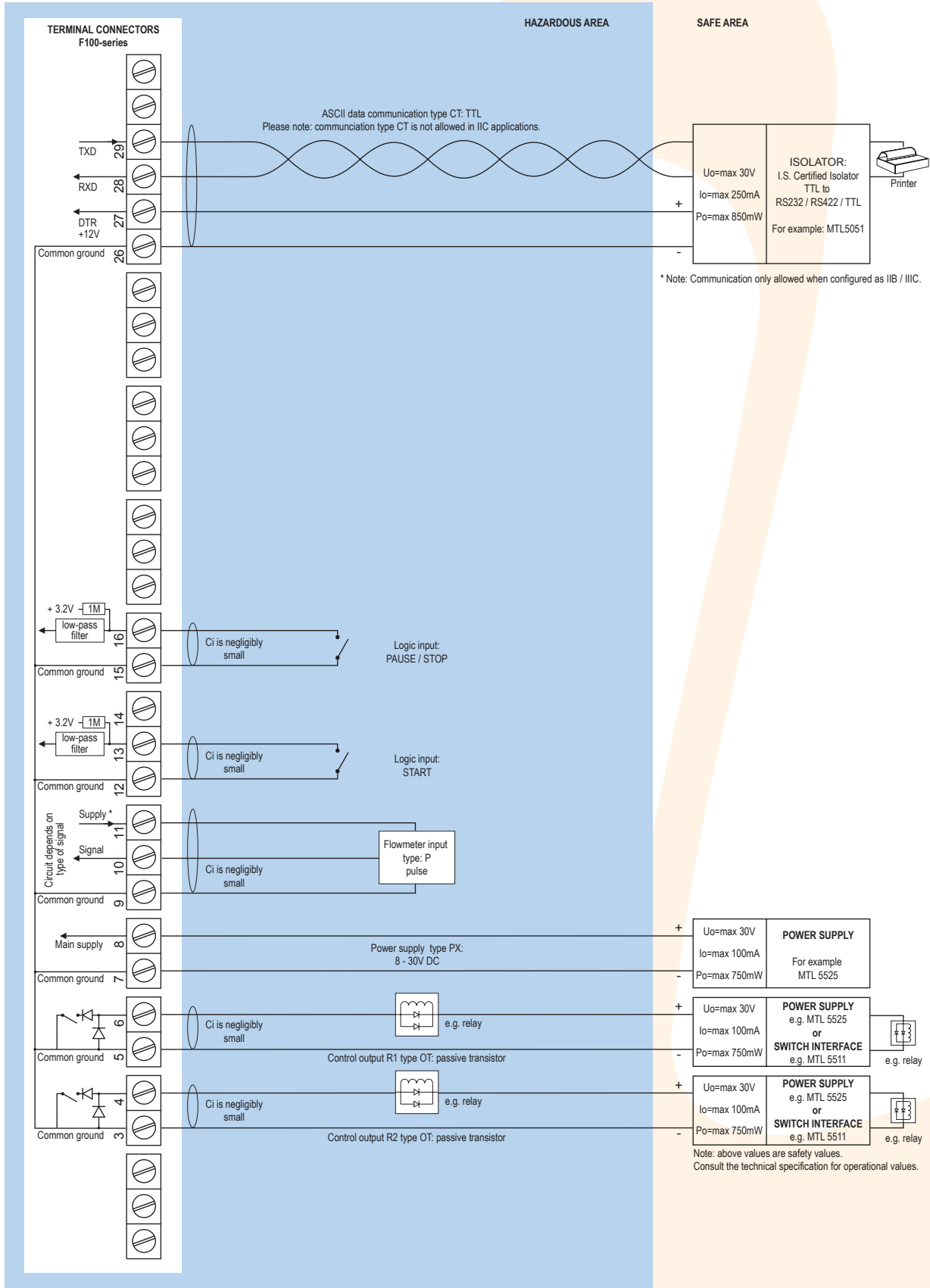

\* Note sensor supply voltage: 1.2V DC for coil sensors or 3.2V DC for other pulse sensors.



## Configuration example IIB / IIC and IIC - F132-P-(CT)-OT-PD-XI - Power supply 16 - 30V DC

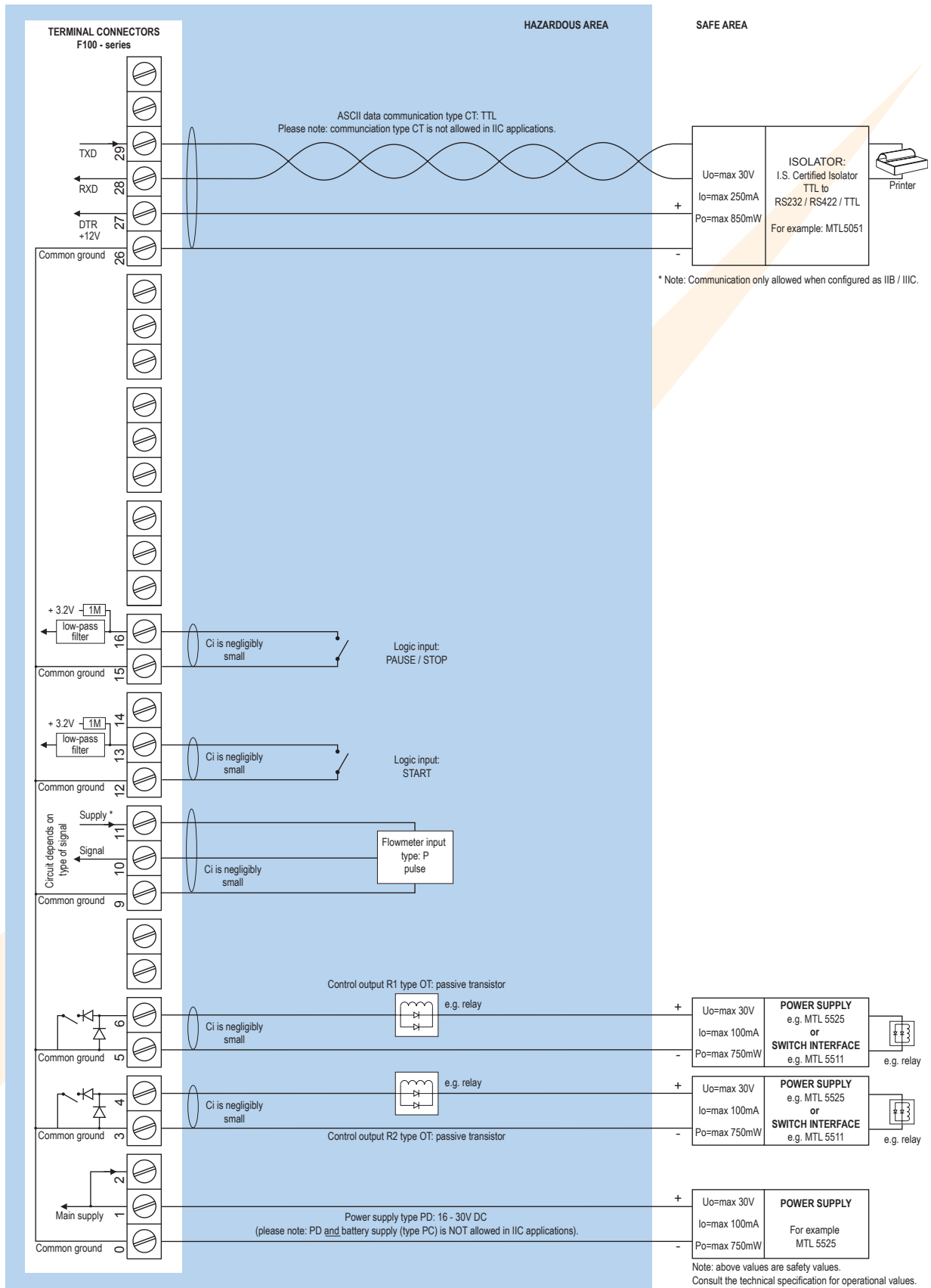

\* Note power supply type PD: the supply voltage to pulse sensors is maximum 8.7V (Uo=max 8.7V Io=max 25mA Po=max 150mW).

## Technical specification

### General

#### Display

Type	High intensity reflective numeric and alphanumeric LCD, UV-resistant.
Dimensions	90 x 40mm (3.5" x 1.6").
Digits	Seven 17mm (0.67") and eleven 8mm (0.31") digits. Various symbols and measuring units.
Refresh rate	User definable: 8 times/sec. - 1 time/30 secs.
Option ZB	Transflective LCD with green LED backlight. Good readings in full sunlight and darkness.
Note ZB	Only available for safe area applications.

#### Operating temperature

Standard unit	-40°C to +80°C (-40°F to +176°F).
Intrinsically Safe	-40°C to +70°C (-40°F to +158°F).

#### Power requirements

Type PB	Long life Lithium battery - life-time depends upon settings and configuration - up to 5 years.
Type PC	Intrinsically Safe long life lithium battery - life-time depends upon settings and configuration - up to 5 years.
Type PD	8 - 24V AC / DC $\pm$ 10%. Power consumption max. 10 Watt. Intrinsically Safe: 16 - 30V DC; power consumption max. 0.75 Watt.
Type PF	24V AC / DC $\pm$ 10%. Power consumption max. 15 Watt.
Type PM	115 - 230V AC $\pm$ 10%. Power consumption max. 15 Watt.
Type PX	8 - 30V DC. Power consumption max. 0.5 Watt.
Type ZB	Internally powered, only available with type PD / PF / PM. Power consumption max. 1 Watt.
Note PB/PF/PM	Not available Intrinsically Safe.
Note PF/PM	The total consumption of the sensors and outputs may not exceed 400mA @ 24V.
Note	For Intrinsically Safe applications, consult the safety values in the certificate.

#### Sensor excitation

Type PB/PC/PX	3.2V DC for pulse signals and 1.2V DC for coil pick-up.
Note	This is not a real sensor supply. Only suitable for sensors with a very low power consumption like coils (sine wave) and reed-switches.
Type PD	1.2 / 3.2 / 8.2 / 12 / 24V DC - max. 50mA @ 24V DC.
Type PD-XI	1.2 / 3.2 / 8.2V DC - max. 7mA @ 8.2V DC and mains power supply voltage (as connected to terminal 1).
Type PF / PM	1.2 / 3.2 / 8.2 / 12 / 24V DC - max. 400mA @ 24V DC.

#### Terminal connections

Type	Removable plug-in terminal strip. Wire max. 1.5mm <sup>2</sup> and 2.5mm <sup>2</sup> .
------	---

#### Data protection

Type	EEPROM backup of all settings. Backup of running totals every minute. Data retention at least 10 years.
Pass-code	Configuration settings can be pass-code protected.

### Casing

#### General

Window	Polycarbonate window.
Sealing	Silicone.
Control keys	Three industrial micro-switch keys. UV-resistant silicone keypad.

#### Aluminum wall / field mount enclosures

General	Die-cast aluminum wall/field mount enclosure IP67 / NEMA 4X with 2-component UV-resistant coating.
Dimensions	130 x 120 x 75mm (5.12" x 4.72" x 2.95") - W x H x D.
Weight	1100 gr.
Type HA	Cable entry: 2 x PG9 and 1 x M20.
Type HM	Cable entry: 2 x M16 and 1 x M20.
Type HN	Cable entry: 1 x M20.
Type HO	Cable entry: 2 x M20.
Type HP	Cable entry: 6 x M12.
Type HT	Cable entry: 1 x 1/2" NPT.
Type HU	Cable entry: 3 x 1/2" NPT.
Type HV	Cable entry: 4 x M20.
Type HZ	Cable entry: no holes.

#### GRP wall / field mount enclosures

General	GRP wall/field mount enclosure IP67 / NEMA 4X, UV-resistant and flame retardant.
Dimensions	130 x 120 x 75mm (5.12" x 4.72" x 2.95") - W x H x D.
Weight	600 gr.
Type HD	Cable entry: no holes.
Type HE	Cable entry: 2 x $\emptyset$ 16mm and 1 x $\emptyset$ 20mm.
Type HF	Cable entry: 1 x $\emptyset$ 22mm (7/8").
Type HG	Cable entry: 2 x $\emptyset$ 20mm.
Type HH	Cable entry: 6 x $\emptyset$ 12mm.
Type HJ	Cable entry: 3 x $\emptyset$ 22mm (7/8").
Type HK	Flat bottom, cable entry: no holes.

#### Panel mount enclosures



Dimensions	130 x 120 x 60mm (5.12" x 4.72" x 2.36") - W x H x D.
Panel cut-out	115 x 98mm (4.53" x 3.86") L x H.
Type HB	Die-cast aluminum panel mount enclosure IP65 / NEMA 4X.
Weight	600 gr.
Type HC	GRP panel mount enclosure IP65 / NEMA 4X, UV-resistant and flame retardant.
Weight	450 gr.

#### ABS wall / field mount enclosures

General	Silicone free ABS wall/field mount enclosure IP65 with EPDM and PE sealings. UV-resistant polyester keypad (old HD enclosure).
Dimensions	130 x 114 x 71mm (5.1" x 4.5" x 2.8") - W x H x D.
Weight	450 gr.
Type HS	Cable entry: no holes.

## Hazardous area

### Intrinsically Safe (Type XI)

ATEX certification	 II 1 G Ex ia IIB/IIC T4 Ga. II 1 D Ex ia IIIC T100 °C Da IP6X.
IECEX certification	 Ex ia IIC/IIB T4 Ga. Ex ia IIIC T100 °C Da IP6X.
Ambient Ta	-40°C to +70°C (-40°F to +158°F).

### Explosion proof (Type XF)

ATEX certification	 II 2 GD EEx d IIB T5.
Dimensions	300 x 250 x 200mm (11.8" x 9.9" x 7.9") L x H x D.
Weight	Appr. 15kg.

### Environment

Electromagnetic compatibility	Compliant ref: EN 61326 (1997), EN 61010-1 (1993).
-------------------------------	--

## Signal inputs

### Flowmeter

Type P	Coil / sine wave (minimum 20mVpp or 80mVpp - sensitivity selectable), NPN/PNP, open collector, reed-switch, Namur, active pulse signals 8 - 12 and 24V DC.
Frequency	Minimum 0Hz - maximum 7kHz for total and flow rate. Maximum frequency depends on signal type and internal low-pass filter. E.g. reed switch with low-pass filter: max. frequency 120Hz.
K-Factor	0.000010 - 9,999,999 with variable decimal position.
Low-pass filter	Available for all pulse signals.
Option ZF	coil sensitivity 10mVpp.

### Logic inputs

Function	Two terminal inputs to start, pause and stop the batch process.
Type	Internally pulled-up switch contact - NPN.
Duration	Minimum pulse duration 100msec.

## Signal outputs

### Control / pulse output

Function	User defined: batch process one or two stage control.
Type OA	Two active 24V DC transistor outputs (PNP); max. 50mA per output (requires PD, PF or PM).
Type OR	Two electro-mechanical relay outputs (N.O.) - isolated; max. switch power 230V AC - 0.5A per relay (requires PF or PM).
Type OT	Two passive transistor outputs (NPN) - not isolated. Max. 50V DC - 300mA per output.

### Printer communication option

Function	Send a "print receipt" command after every batch.
Protocol	ASCII data.
Speed	1200 - 2400 - 4800 - 9600 baud.
Type CB	RS232
Type CH	RS485 2-wire
Type CI	RS485 4-wire
Type CT	TTL Intrinsically Safe.

## Operational

### Operator functions

Displayed functions	<ul style="list-style-type: none"> <li>• Preset value - can be entered by the operator.</li> <li>• Batched quantity or remaining quantity.</li> <li>• Total and accumulated total.</li> <li>• Nr. of batches.</li> <li>• Reprint the last receipt.</li> <li>• No-flow alarm.</li> </ul>
---------------------	---

### Preset and total

Digits	7 digits.
Units	L, m <sup>3</sup> , GAL, USGAL, kg, lb, bbl, no unit.
Decimals	0 - 1 - 2 or 3.
Note	Total can be reset to zero.

### Accumulated total

Digits	11 digits.
Units / decimals	According to selection for total.
Note	Can not be reset to zero.

## Accessories

### Mounting accessories

ACFo2	Stainless steel wall mounting kit.
ACFo5	Stainless steel pipe mounting kit (worm gear clamps not included).
ACFo6	Two stainless steel worm gear clamps Ø 44 - 56mm.
ACFo7	Two stainless steel worm gear clamps Ø 58 - 75mm.
ACFo8	Two stainless steel worm gear clamps Ø 77 - 95mm.
ACFo9	Two stainless steel worm gear clamps Ø 106 - 138mm.
ACFo10	Customized Grevopal tagplates for ACFo2 and ACFo5, including stainless steel screws. Dimension: 95mm x 12.5mm (3.75" x 0.50").

### Cable gland accessories

ACF20	For HA enclosure, includes O-rings.
ACF25	For HE enclosure, includes locknuts and O-rings.
ACF26	For HF enclosure, includes locknuts and O-rings.
ACF27	For HG enclosure, includes locknuts and O-rings.
ACF28	For HH enclosure, includes locknuts and O-rings.
ACF29	For HJ enclosure, includes locknuts and O-rings.
ACF32	For HM enclosure, includes O-rings.
ACF33	For HN enclosure, includes O-rings.
ACF34	For HO enclosure, includes O-rings.
ACF35	For HP enclosure, includes O-rings.
ACF39	For HT enclosure, includes O-rings.
ACF40	For HU enclosure, includes O-rings.

### Blind plug accessories

ACF50	For HA enclosure, includes O-rings.
ACF55	For HE enclosure, includes locknuts and O-rings.
ACF56	For HF enclosure, includes locknuts and O-rings.
ACF57	For HG enclosure, includes locknuts and O-rings.
ACF58	For HH enclosure, includes locknuts and O-rings.
ACF59	For HJ enclosure, includes locknuts and O-rings.
ACF62	For HM enclosure, includes O-rings.
ACF63	For HN enclosure, includes O-rings.
ACF64	For HO enclosure, includes O-rings.
ACF65	For HP enclosure, includes O-rings.
ACF69	For HT enclosure, includes O-rings.
ACF70	For HU enclosure, includes O-rings.

## Ordering information

Standard configuration: F132-P-AX-CX-EX-HC-IX-OT-PX-TX-XX-ZX.

Ordering information: F132 - -AX -C -EX -H -IX -O -P -TX -X -Z

### Flowmeter input signal

P  Pulse input: coil, npn, pnp, namur, reed-switch.

### Analog output signal

AX  No analog output.

### Printer communication

CB Communication RS232 - ASCII data.

CH Communication RS485 - 2-wire - ASCII data.

CI Communication RS485 - 4-wire - ASCII data.

CT  Intrinsically Safe TTL - ASCII data.

CX  No printer communication.

### Flow equations

EX  No flow equations.

### Panel mount enclosures - IP65 / NEMA4X

HB  Aluminum enclosure.

HC  GRP enclosure.

### GRP field / wall mount enclosures - IP67 / NEMA4X

HD  Cable entry: no holes.

HE  Cable entry: 2 x Ø 16mm & 1 x Ø 20mm.

HF  Cable entry: 1 x Ø 22mm (7/8").

HG  Cable entry: 2 x Ø 20mm.

HH  Cable entry: 6 x Ø 12mm.

HJ  Cable entry: 3 x Ø 22mm (7/8").

HK  Flat bottom, cable entry: no holes.

### Aluminum field / wall mount enclosures - IP67 / NEMA4X

HA  Cable entry: 2 x PG9 + 1 x M20.

HM  Cable entry: 2 x M16 + 1 x M20.

HN  Cable entry: 1 x M20.

HO  Cable entry: 2 x M20.

HP  Cable entry: 6 x M12.

HT  Cable entry: 1 x 1/2"NPT.

HU  Cable entry: 3 x 1/2"NPT.

HV  Cable entry: 4 x M20.

HZ  Cable entry: no holes.

### ABS field / wall mount enclosures - IP65

HS  Silicone free ABS field enclosure – Cable entry: no holes (old HD enclosure).

### Additional inputs

IX  No additional input.

### Outputs

OA Two active transistor outputs - requires PD, PF or PM.

OR Two mechanical relay outputs - requires PF or PM.

OT  Two passive transistor outputs - standard configuration.

### Power supply

PB Lithium battery powered.

PC  Lithium battery powered - Intrinsically Safe.

PD  8 - 24V AC/DC + sensor supply - with XI: 16 - 30V DC.

PF 24V AC/DC + sensor supply.

PM 115 - 230V AC + sensor supply.

PX  Basic power supply 8 - 30V DC (no real sensor supply).

### Temperature input signal

TX  No temperature input signal.

### Hazardous area

XI  Intrinsically Safe, according ATEX and IECEx.

XF EExd enclosure - 3 keys.

XX Safe area only.

### Other options

ZB Backlight - requires PD, PF or PM.

ZF  Coil input 10mVpp.

ZX  No options.

The bold marked text contains the standard configuration.

 Available Intrinsically Safe.

