

TEMPERATURE MONITOR

WITH ANALOG AND HIGH / LOW
ALARMS OUTPUTS



Advantages

- Robust IP67 (NEMA Type4X) field enclosure. It is so rugged, **you can even stand on it!**
- Intrinsically Safe available - ATEX and IECEx approval for gas and dust applications.
- Programming can be done by your own crew, with the sensible menu-driven structure, saving cost and irritation. **Know one, know them all!**
- Very diverse mounting possibilities: walls, pipes, panels or directly onto outdoor sensors!

Features

- Displays actual temperature and alarm values.
- 4 alarm values can be entered: low-low, low, high and high-high temperature alarm.
- Large 17mm (0.67") digits.
- Selectable on-screen engineering units °C - °F - K.
- Explosion/flame proof available.
- Full Modbus communication RS232/485/TTL.
- Loop or battery powered, 8 - 24V AC/DC or 115 - 230V AC power supply.
- Sensor supply 3 / 8.2 / 12 / 24V DC.
- LED backlight option.

Signal output

- Up to 4 free configurable alarm outputs.
- (0)4 - 20mA / 0 - 10V DC according to the temperature.

Signal input

- Temperature
- (0)4 - 20mA.
 - 0 - 10V DC.

Applications

- The F-Series is your first and safest choice for field mount indicators in safe and hazardous area applications. Especially in harsh weather conditions like rain, snow, salty atmospheres and temperatures between -40°C up to +80°C (-40°F up to 176°F).
- For applications where continuous temperature measurement and monitoring is important. Also re-transmission of the actual temperature or serial communication is required. Alternative basic model: Fo40 - Fo43 or the D-Series DIN panel mount indicators.

General information

Introduction

The F143 is a versatile temperature indicator with continuous temperature monitoring feature. It offers the facility to set two low temperature and two high temperature alarm values. If desired, an ignore function can be set up to allow for an incorrect temperature for a certain period of time. Up to four outputs are available to transmit the alarm condition. A wide selection of options further enhances the capabilities of this model, including Intrinsic Safety and full Modbus communication.

Display

The display has large 17mm (0.67") and 8mm (0.31") digits which displays the temperature, measuring unit and alarm values. The alarm values can be password protected. On-screen engineering units are easily configured from a comprehensive menu.

Configuration

All configuration settings are accessed via a simple operator menu which can be password protected. Each setting is clearly indicated with an alphanumeric description, which avoids confusing abbreviations. All settings are safely stored in EEPROM memory in the event of sudden power failure.

Analog output signal

The actual temperature is re-transmitted with the (0)4 - 20mA or 0 - 10V DC output signal. The output signal is updated eight times per second with a filter function being available to smoothen out the signal if desired. The output value is user defined in relation to the temperature, e.g. 4mA equals to -20°C and 20mA equals to 250 °C. The output signal can be passive, active or isolated where the passive output type will loop power the F143 as well.

Alarm output

Up to four configurable outputs are available to transmit the alarm condition. You can have e.g. two the same low alarm outputs, one high alarm output and one "all alarms" output. Type OS offers four mechanical relay outputs. However, only two outputs are available in Intrinsically Safe applications. Three outputs are available in all other configurations. The output

signals can be a passive NPN, active PNP or an isolated electro-mechanical relay.

Signal input

The F143 does accept (0)4 - 20mA and 0 - 10V input signals from any type of temperature measurement device.

Communication

All process data and settings can be read and modified manually or through the Modbus communication link (RS232 / RS485).

Full Modbus functionality remains available for the Intrinsically Safe version (TTL).

Hazardous areas

This model has been ATEX and IECEx certified Intrinsically Safe for gas and dust applications, with an allowed ambient temperature of -40°C to +70°C (-40°F to +158°F). A flame proof Ex d enclosure with ATEX certification is also available.

Enclosures

Various types of enclosures can be selected, all ATEX and IECEx approved. As standard the F143 is supplied in an GRP panel mount enclosure, which can be converted to an IP67 / NEMA Type4X GRP field mount enclosure by the addition of a back case. Most popular is our rugged aluminum field mount enclosure with IP67 / NEMA Type4X rating. Both European or U.S. cable gland entry threads are available.

Overview application F143

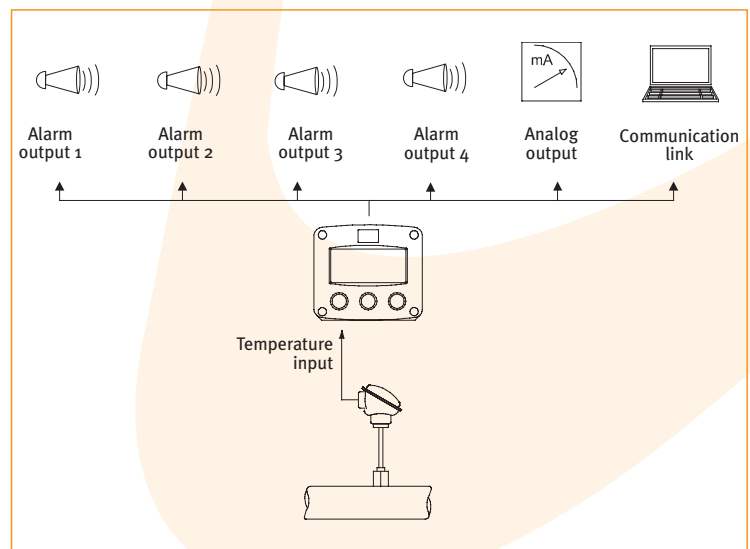

Dimensions enclosures

Aluminum & GRP panel mount enclosure

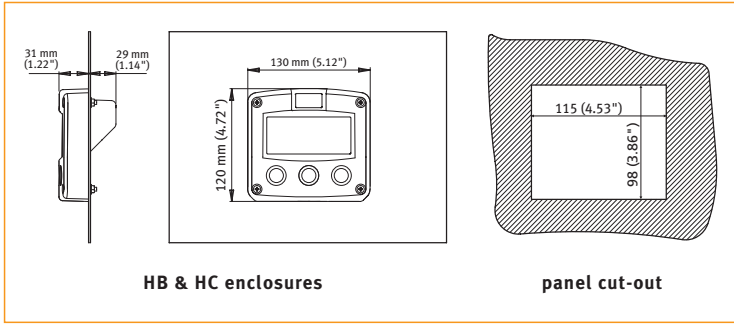

HB & HC enclosures

panel cut-out

Aluminum & GRP field / wall mount enclosures

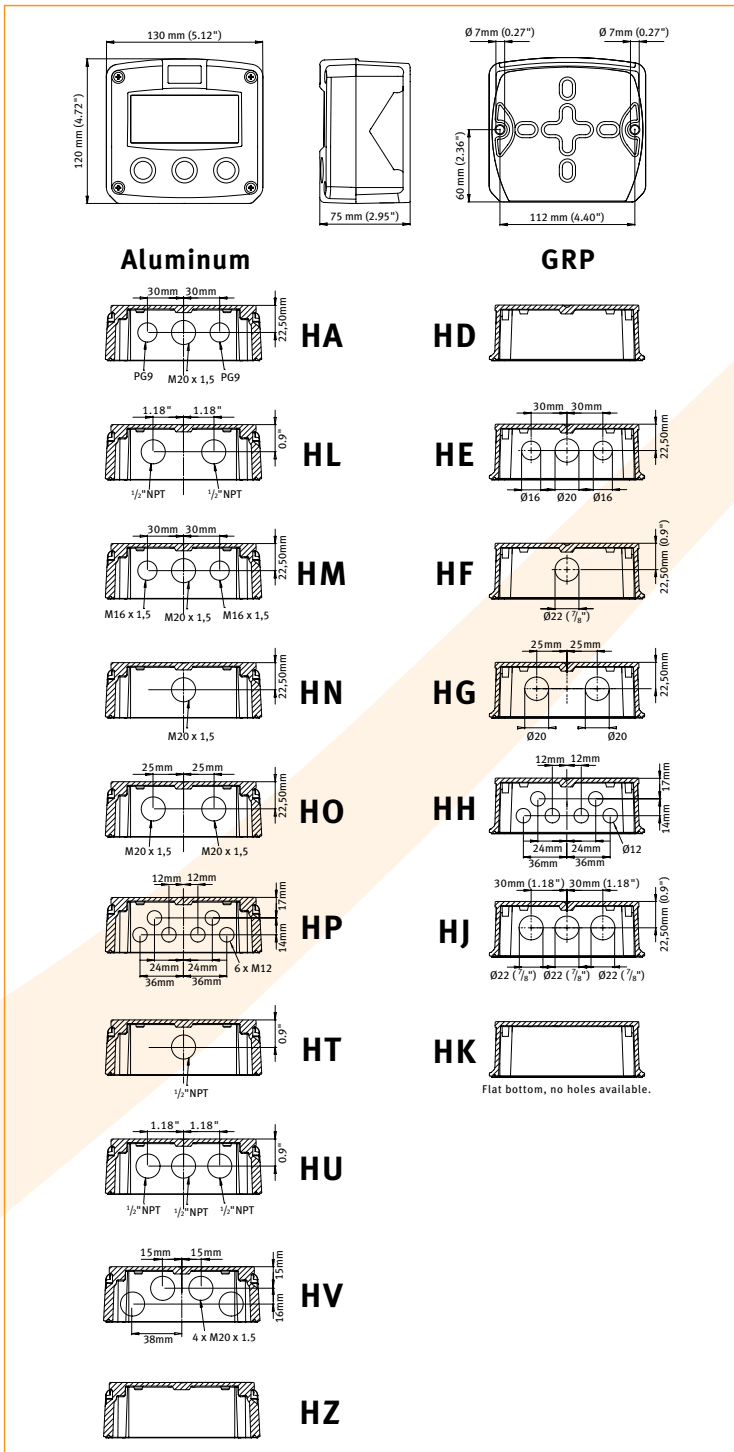

Aluminum

GRP

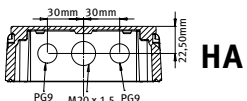

HA

HD

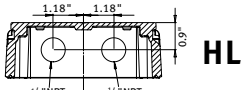

HL

HE

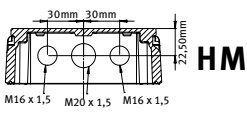

HM

HF

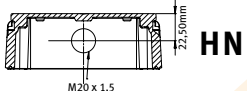

HN

HG

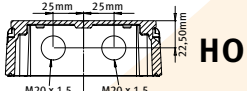

HO

HH

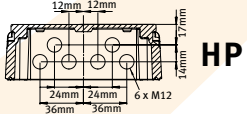

HP

HJ

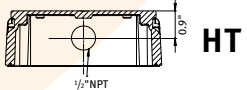

HT

HK

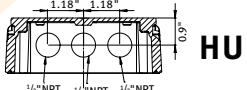

HU

Flat bottom, no holes available.

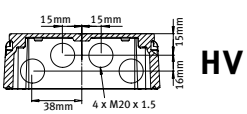

HV

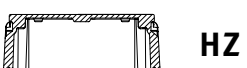

HZ

Terminal connections

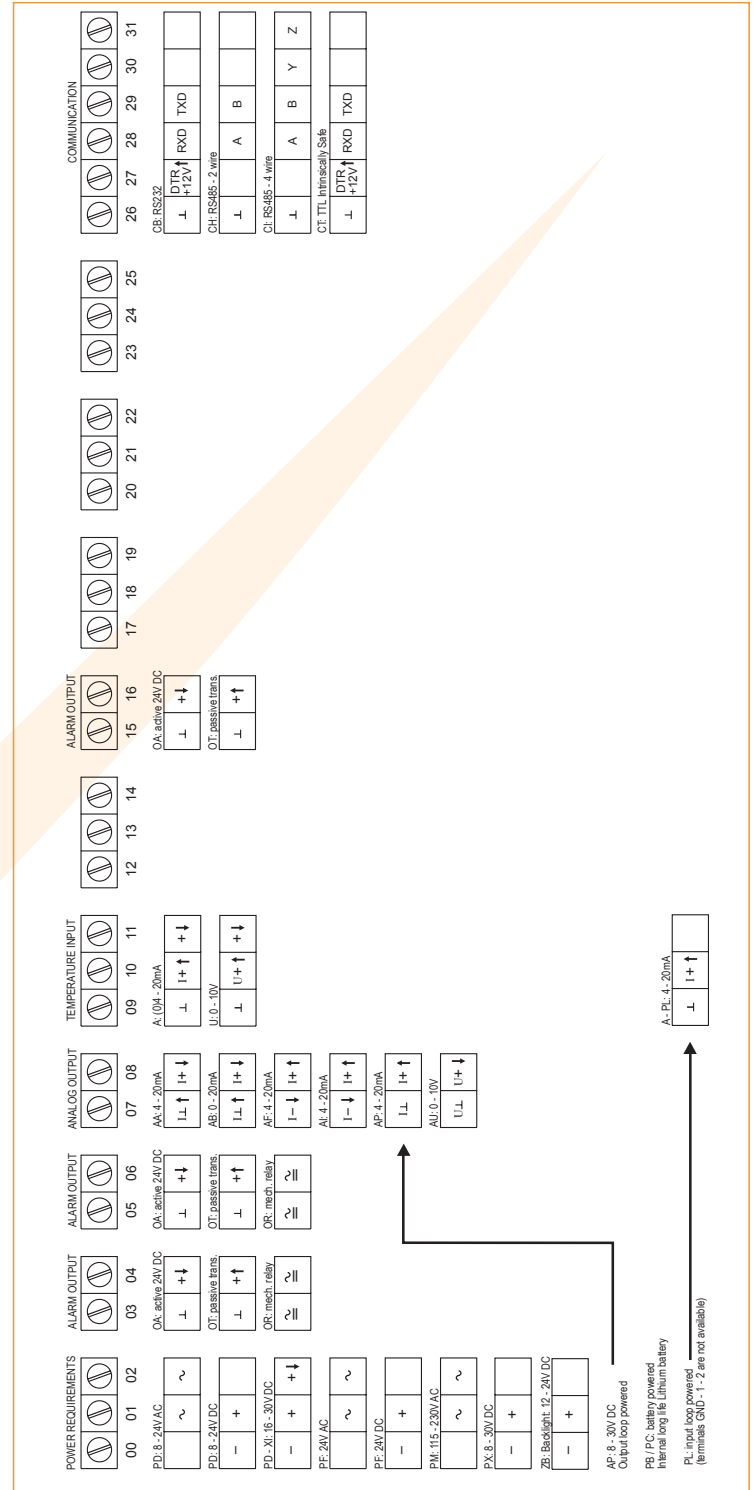

Display example - 90 x 40mm (3.5" x 1.6")

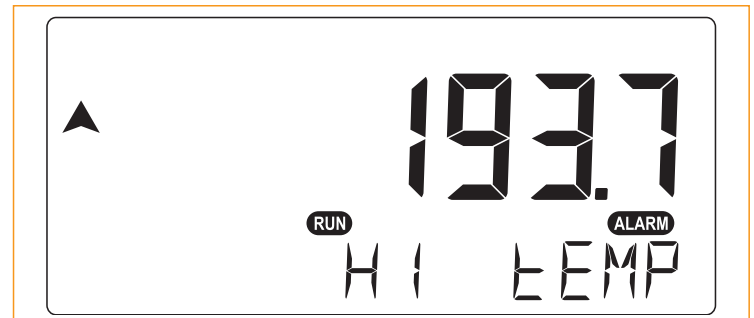

Typical wiring diagram F143-A-AP-CH-OT-PX

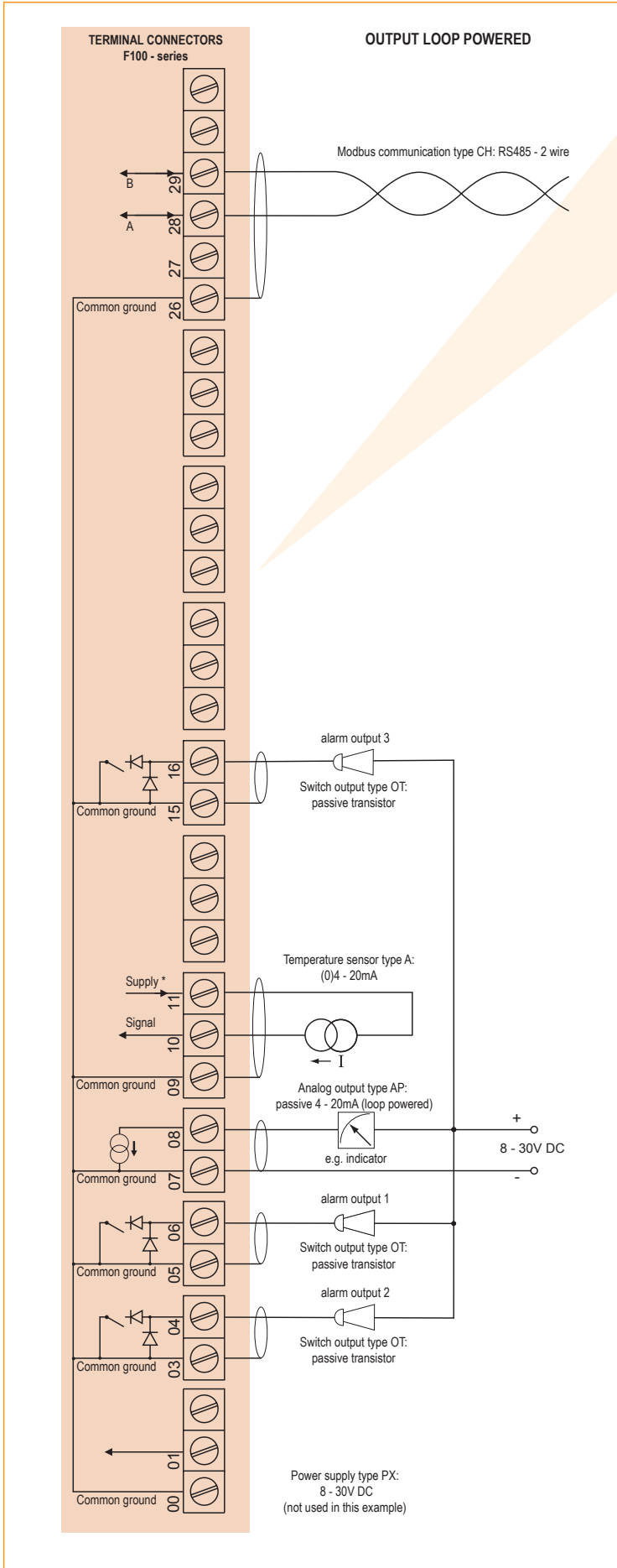

Typical wiring diagram F143-A-AA-CB-OA-PD

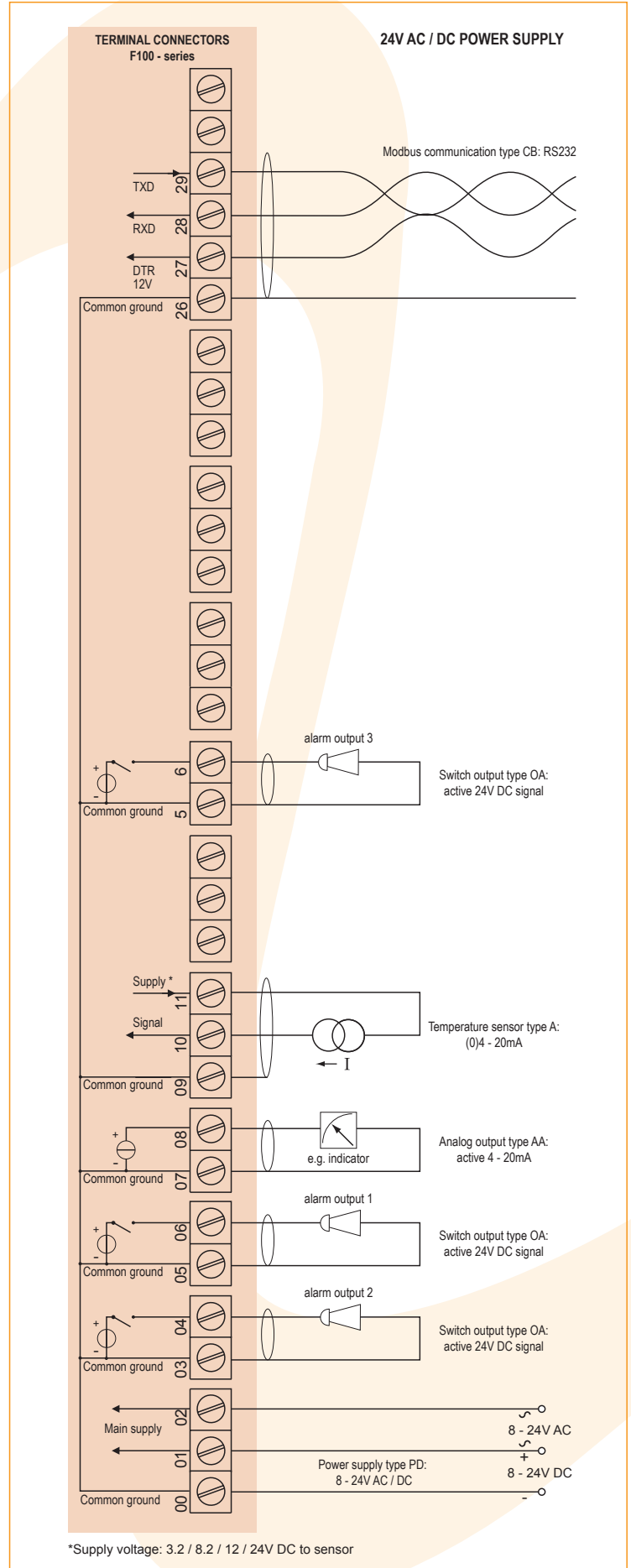

*Supply voltage: 3.2 / 8.2 / 12 / 24V DC to sensor

Typical wiring diagram F143-A-AI-CI-OR-PM

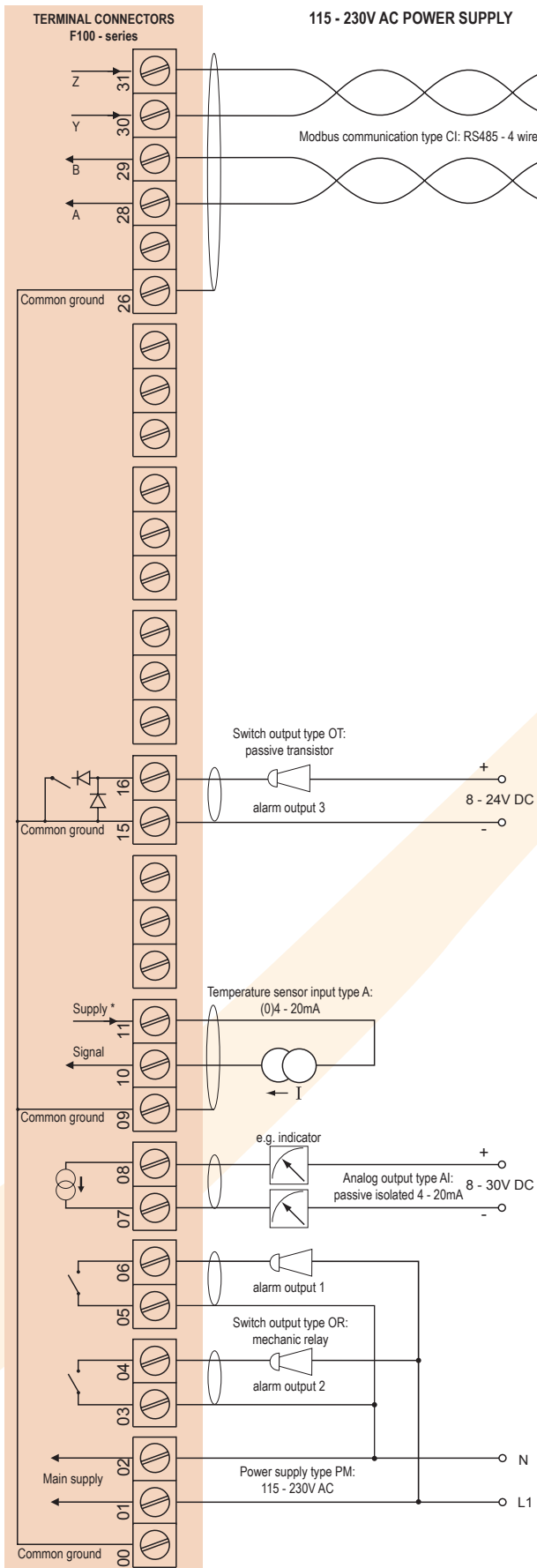

*Supply voltage: 3.2 / 8.2 / 12 / 24V DC to sensor

Typical wiring diagram F143-A-AP-CB-OS-PD

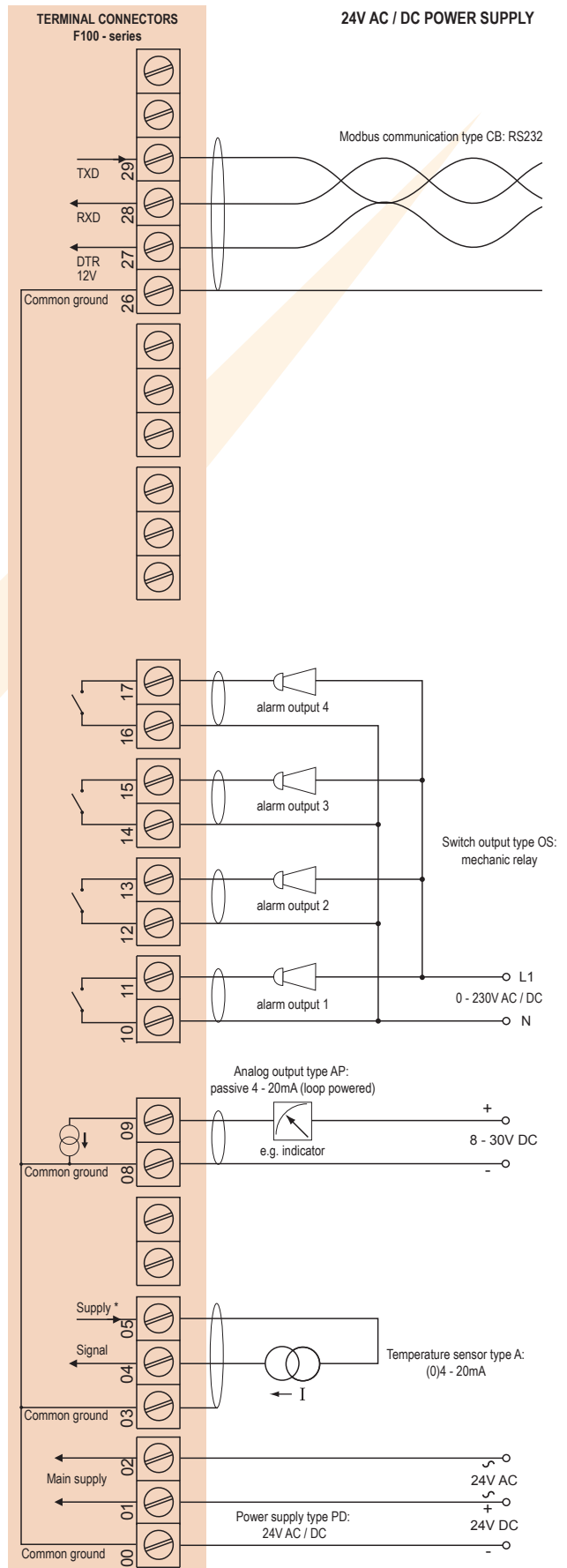

*Supply voltage: 3.2 / 8.2 / 12 / 24V DC to sensor

Hazardous area applications

The F143-XI has been certified according ATEX and IECEx by DEKRA for use in Intrinsically Safe applications with an ambient temperature of -40°C to +70°C (-40°F to +158°F).

- The ATEX markings for gas and dust applications are:

II 1 G Ex ia IIB/IIC T4 Ga
II 1 D Ex ia IIIC T100 °C Da.

- The IECEx markings for gas and dust applications are: **Ex ia IIC/IIB T4 Ga** and **Ex ia IIIC T100 °C Da.**

Besides the I.S. power supplies for the two alarm outputs, it is allowed to connect up to three I.S. power supplies in IIB/IIIC applications or one in IIC applications. Consult the certificate for the maximum input and output values of the circuits. Full functionality of the F143 remains available, including two alarm outputs and 4 - 20mA output and Modbus communication (type CT). Power supply type PD-XI offers a sensor supply according to the connected power supply voltage at terminal 1. An ATEX approved flame proof Ex d enclosure is available as well. Please contact your supplier for further details.

Certificate of conformity KEMA 03ATEX1074 X

• IECEx DEK 11.0042X



Configuration example IIB / IIIC and IIC F143-A-(AP)-(OT)-PC-XI - Battery powered unit

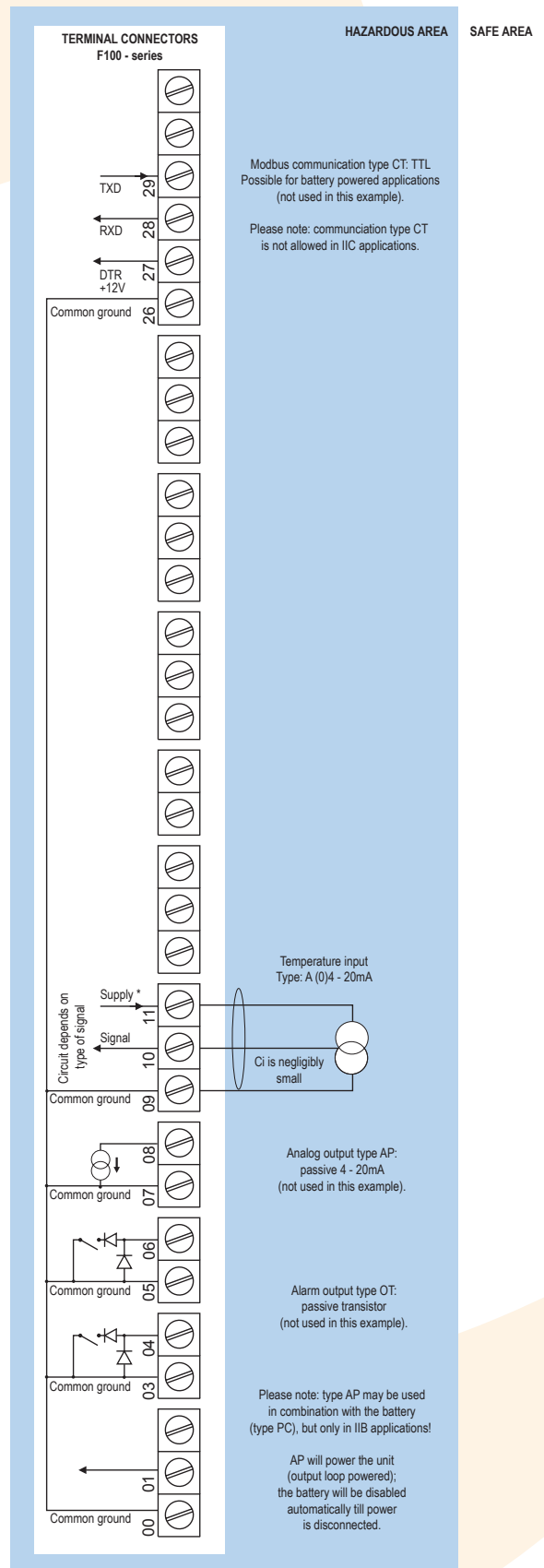

Configuration example IIB / IIIC - F143-A-AP-CT-OT-(PX)-XI - Output loop powered

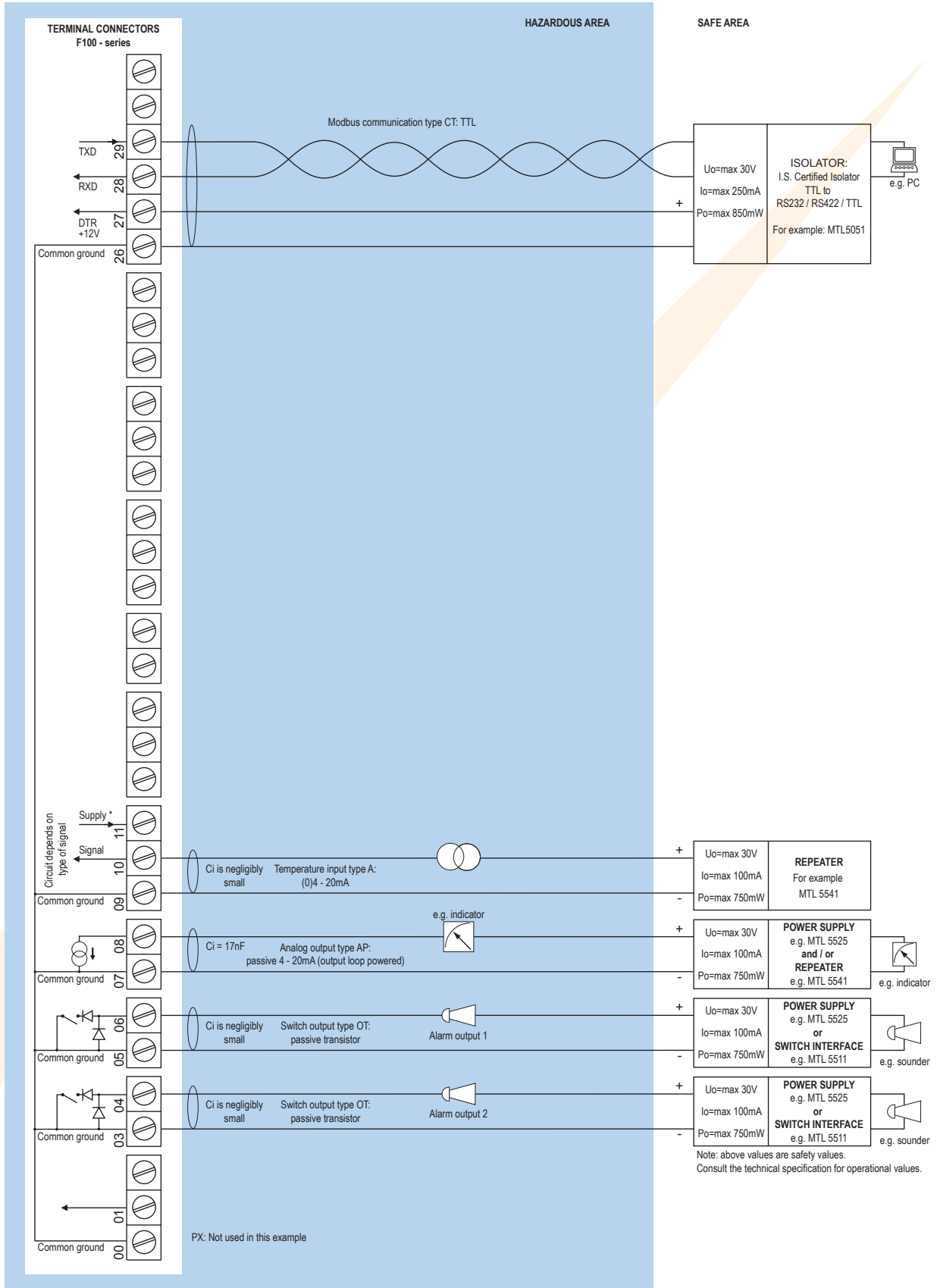

* Note sensor supply voltage: 3.2V DC - not suitable to power analog sensors.

Configuration example IIB / IIC - F143-A-AF-CT-OT-PC-XI - Battery powered unit

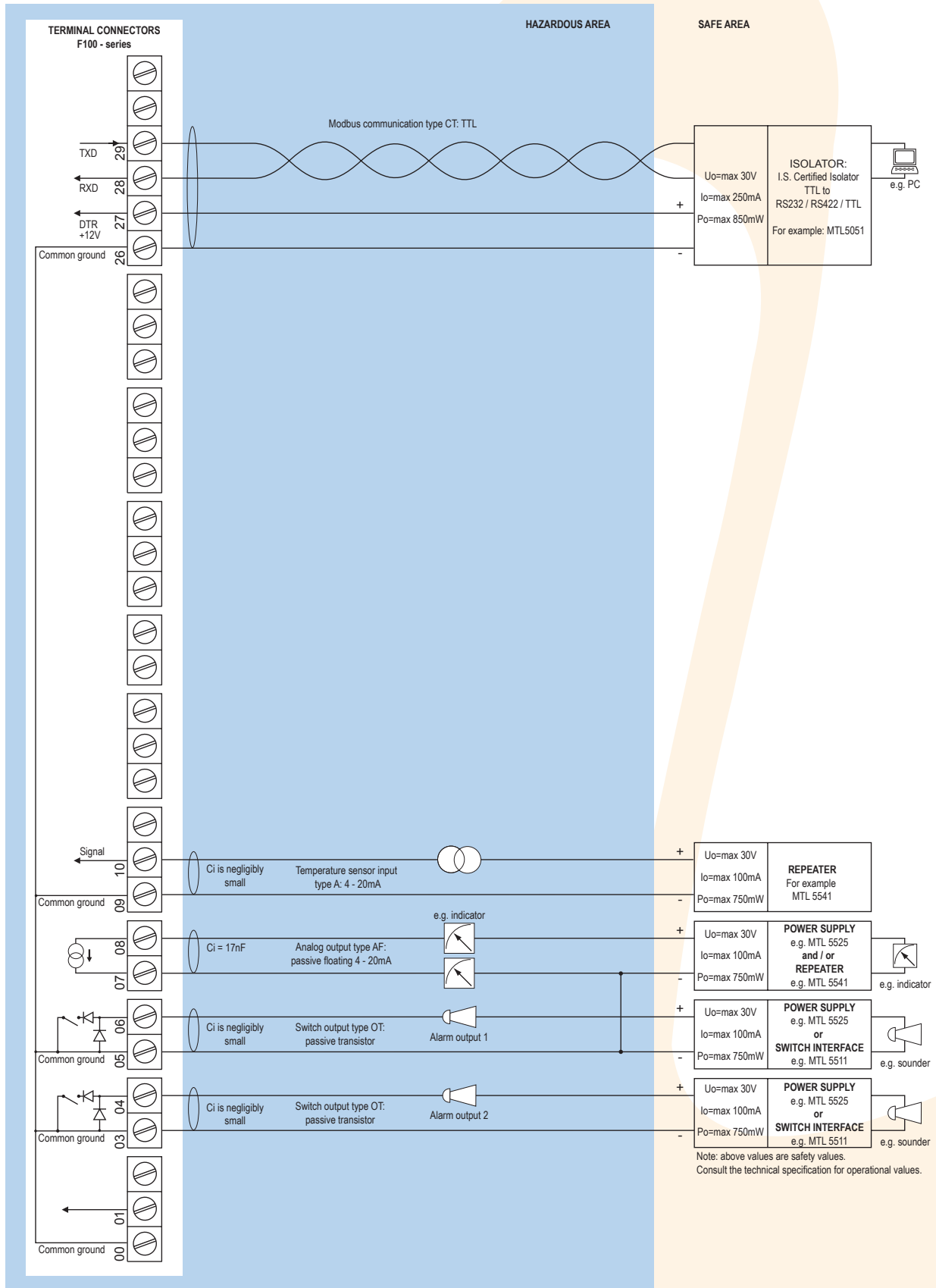

Configuration example IIB / IIC and IIC - F143-A-AP-(CT)-OT-PD-XI - Power requirement 16 - 30V DC

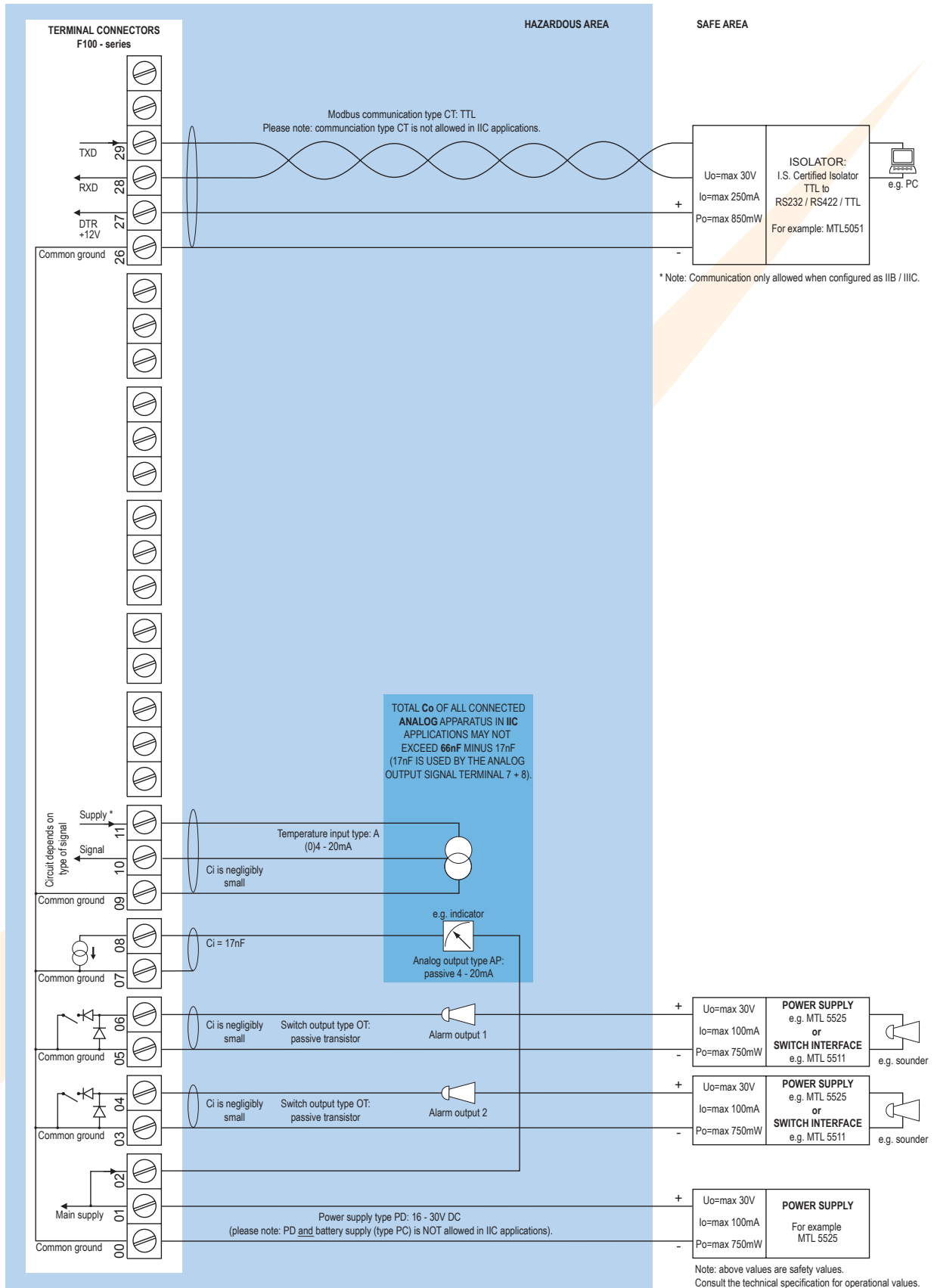

* Note power supply type PD: the supply voltage to sensors is as connected to terminal 1 (internally linked).

Technical specification

General

Display	
Type	High intensity reflective numeric and alphanumeric LCD, UV-resistant.
Dimensions	90 x 40mm (3.5" x 1.6").
Digits	Seven 17mm (0.67") and eleven 8mm (0.31") digits. Various symbols and measuring units.
Refresh rate	User definable: fast, 1sec, 3sec, 15sec, 30sec, off.
Option ZB	Transflective LCD with white LED-backlight. Good readings in full sunlight and darkness.
Note ZB	Only available for safe area applications.

Ambient temperature

Safe areas	-40°C to +80°C (-40°F to +176°F).
Intrinsically Safe	-40°C to +70°C (-40°F to +158°F).

Power requirements

Type AP	Analog output loop powerd, 8 - 30V DC. Power consumption max 0.5 Watt.
Type PB	Long life Lithium battery - life-time depends upon settings and configuration - up to 5 years. (requires PD, PL or PX)
Type PC	Intrinsically Safe long life lithium battery - life-time depends upon settings and configuration - up to 5 years. (requires XI and PD or PX)
Type PD	8 - 24V AC / DC ± 10%. Power consumption max. 10 Watt. Intrinsically Safe: 16 - 30V DC; power consumption max. 0.75 Watt.
Type PF	24V AC / DC ± 10%. Power consumption max. 15 Watt.
Type PL	Input loop powered from sensor signal 4 - 20mA (type "A") - requires types AI and OT (not Xi).
Type PM	115 - 230V AC ± 10%. Power consumption max. 15 Watt.
Type PX	8 - 30V DC. Power consumption max. 0.5 Watt.
Type ZB	12 - 24V DC ± 10%. Power consumption max. 1 Watt.
Note PB/PF/PM	Not available Intrinsically Safe.
Note PF/PM	The total consumption of the sensors and outputs may not exceed 400mA @ 24V.
Note	For Intrinsically Safe applications, consult the safety values in the certificate.

Sensor excitation

Type PB/PC/PX	3V DC.
Note	This is not a real sensor supply. Only suitable for sensors with a very low power consumption.
Type PD	3 / 8.2 / 12 / 24V DC - max. 50mA @ 24V DC.
Type PD-XI	The sensor supply voltage will be according to power supply as connected to terminal 1.
Type PF / PM	3 / 8.2 / 12 / 24V DC - max. 400mA @ 24V DC.

Terminal connections

Type	Removable plug-in terminal strip. Wire max. 1.5mm ² and 2.5mm ² .
------	---

Data protection

Type	EEPROM backup of all settings. Data retention at least 10 years.
Password	Configuration settings can be password protected.

Directives & Standards

EMC	Directive 2014/30/EU, FCC 47 CFR part 15.
Low voltage	Directive 2014/35/EU
RoHS	Directive 2011/65/EU
ATEX / IECEx	Directive 94/9/EC, IEC 60079-0, IEC 60079-11, IEC 60079-26.
IP & NEMA	EN 60529 & NEMA 250

Enclosure

General	
Window	Polycarbonate window.
Sealing	Silicone.
Control keys	Three industrial micro-switch keys. UV-resistant silicone keypad.

Aluminum wall / field mount enclosures

General	Die-cast aluminum wall/field mount enclosure IP67 / NEMA Type4X with 2-component UV-resistant coating.
Dimensions	130 x 120 x 75mm (5.12" x 4.72" x 2.95") - W x H x D.
Weight	1100 gr.
Type HA	Cable entry: 2 x PG9 and 1 x M20.
Type HL	Cable entry: 3 x 1/2" NPT.
Type HM	Cable entry: 2 x M16 and 1 x M20.
Type HN	Cable entry: 1 x M20.
Type HO	Cable entry: 2 x M20.
Type HP	Cable entry: 6 x M12.
Type HT	Cable entry: 1 x 1/2" NPT.
Type HU	Cable entry: 3 x 1/2" NPT.
Type HV	Cable entry: 4 x M20.
Type HZ	Cable entry: no holes.

GRP wall / field mount enclosures



General	GRP wall/field mount enclosure IP67 / NEMA Type4X, UV-resistant and flame retardant.
Dimensions	130 x 120 x 75mm (5.12" x 4.72" x 2.95") - W x H x D.
Weight	600 gr.
Type HD	Cable entry: no holes.
Type HE	Cable entry: 2 x Ø 16mm and 1 x Ø 20mm.
Type HF	Cable entry: 1 x Ø 22mm (7/8").
Type HG	Cable entry: 2 x Ø 20mm.
Type HH	Cable entry: 6 x Ø 12mm.
Type HJ	Cable entry: 3 x Ø 22mm (7/8").
Type HK	Flat bottom, cable entry: no holes.

Panel mount enclosures

Dimensions	130 x 120 x 60mm (5.12" x 4.72" x 2.36") - W x H x D.
Panel cut-out	115 x 98mm (4.53" x 3.86") L x H.
Type HB	Die-cast aluminum panel mount enclosure IP65 / NEMA Type4X.
Weight	600 gr.
Type HC	GRP panel mount enclosure IP65 / NEMA Type4X, UV-resistant and flame retardant.
Weight	450 gr.

Hazardous area

Intrinsically Safe (Type XI)

ATEX certification	 II 1 G Ex ia IIB/IIC T4 Ga. II 1 D Ex ia IIIC T100 °C Da IP6X.
IECEX certification	 Ex ia IIC/IIB T4 Ga. Ex ia IIIC T100 °C Da IP6X.
Ambient Ta	-40°C to +70°C (-40°F to +158°F).

Explosion proof (Type XF)

ATEX certification	 II 2 G / Ex d IIB T5 Gb. II 2 D / Ex t IIIB T100 °C Db.
Type XF	Dimensions of enclosure: 300 x 250 x 200mm (11.8" x 9.9" x 7.9") L x H x D.
Weight	Appr. 15kg.
Note	IECEX available on request.

Signal inputs

Temperature

Accuracy	Resolution: 14 bit. Error < 0.025mA / ± 0.125% FS. Low level cut-off programmable.
Update time	Four times per second.
Type A	(0)4 - 20mA. Analog input signal can be scaled to any desired range within 0 - 20mA.
Span	0.000010 - 9,999,999 with variable decimal position.
Offset	0.00 - 99,999.99 K.
Voltage drop	2.5V @ 20mA.
Type U	0 - 10V DC. Analog input signal can be scaled to any desired range within 0 - 10V DC.
Span	0.000010 - 9,999,999 with variable decimal position.
Offset	0.00 - 99,999.99 K.
Load impedance	3kOhm.
Note	For signal A and U: power supply to temperature sensor is required; e.g. PD.

Signal outputs

Analog output

Function	Transmitting actual temperature.
Accuracy	10 bit. Error < 0.05%. Analog output signal can be scaled to any desired range.
Update time	Eight times per second.
Type AA	Active 4 - 20mA output (requires PD, PF, PM or PX).
Type AB	Active 0 - 20mA output (requires PD, PF, PM or PX).
Type AF	Passive floating 4 - 20mA output for Intrinsically Safe applications (requires XI + PD or PX).
Type AI	Passive galvanically isolated 4 - 20mA output - also available for battery powered models.
Type AP	Passive 4 - 20mA output - not isolated. Unit will be loop powered.
Type AU	Active 0 - 10V DC output (requires PD, PF, PM or PX).

Communication option

Function	Reading display information, reading / writing all configuration settings.
Protocol	Modbus ASCII / RTU.
Speed	1200 - 2400 - 4800 - 9600 baud.
Addressing	Maximum 255 addresses.
Type CB	RS232
Type CH	RS485 2-wire
Type CI	RS485 4-wire
Type CT	TTL Intrinsically Safe.

Digital outputs

Function	User defined: low, low-low, high, high-high or all alarms output.
Type OA	Three active 24V DC transistor outputs (PNP); max. 50mA per output (requires PD, PF or PM).
Type OR	Two electro-mechanical relay outputs isolated (N.O.) - max. switch power 230V AC - 0.5A (requires PF or PM) and one transistor output OT or OA.
Type OS	Four electro-mechanical relay outputs - isolated; max. switch power 230V AC - 0.5A per relay (requires AP and PD with 24V AC / DC).
Type OT	Three passive transistor outputs (NPN) - not isolated. Max. 50V DC - 300mA per output.
Note	Intrinsically Safe applications: only two transistor outputs type OT available.

Operational

Operator functions

Displayed functions	<ul style="list-style-type: none"> • Actual temperature. • Low - low alarm value. • Low alarm value. • High alarm value. • High - high alarm value. • Alarm values can be set (or only displayed).
---------------------	--

Temperature

Digits	6 digits.
Units	°C, °F or K.
Decimals	Type A / U: 3.

Alarm values

Digits	7 digits.
Units	According to the settings for temperature.
Decimals	According to the settings for temperature.
Time units	According to the settings for temperature.
Type of alarm	Low, high, low-low or high-high temperature alarm. Includes alarm delay time and configurable alarm outputs.

Accessories

Mounting accessories

ACFo2	Stainless steel wall mounting kit.
ACFo5	Stainless steel pipe mounting kit (worm gear clamps not included).
ACFo6	Two stainless steel worm gear clamps Ø 44 - 56mm.
ACFo7	Two stainless steel worm gear clamps Ø 58 - 75mm.
ACFo8	Two stainless steel worm gear clamps Ø 77 - 95mm.
ACFo9	Two stainless steel worm gear clamps Ø 106 - 138mm.
ACF11	Swivel with 25° movement from center axis for direct flowmeter mounting: 1" NPT to 1/2" NPT.



Ordering information

Standard configuration: F143-A-AP-CX-HC-OT-PX-XX-ZX.



Ordering information:

F143 _ -A _ -C _ -H _ -O _ -P _ -X _ -Z _



Temperature input signal

- A**  **(0)4 - 20mA input.**
U  0 - 10V DC input.



Analog output signal

- AA** Active 4 - 20mA output - requires PD, PF, PM or PX.
AB Active 0 - 20mA output - requires PD, PF, PM or PX
AF  I.S. floating 4 - 20mA output - requires XI + PD or PX.
AI Isolated 4 - 20mA output.
AP  **Passive 4 - 20mA output, loop powered unit.**
AU Active 0 - 10V DC output - requires PD, PF, PM or PX.







Communication

- CB** Communication RS232 - Modbus ASCII / RTU.
CH Communication RS485 - 2-wire - Modbus ASCII / RTU.
CI Communication RS485 - 4-wire - Modbus ASCII / RTU.
CT  Intrinsically Safe TTL - Modbus ASCII / RTU.
CX  **No communication.**











Panel mount enclosures - IP65 / NEMA Type4X

- HB**  Aluminum enclosure.
HC  **GRP enclosure.**

GRP field / wall mount enclosures - IP67 / NEMA Type4X

- HD**  Cable entry: no holes.
HE  Cable entry: 2 x Ø 16mm & 1 x Ø 20mm.
HF  Cable entry: 1 x Ø 22mm (7/8").
HG  Cable entry: 2 x Ø 20mm.
HH  Cable entry: 6 x Ø 12mm.
HJ  Cable entry: 3 x Ø 22mm (7/8").
HK  Flat bottom, cable entry: no holes.



Aluminum field / wall mount enclosures - IP67 / NEMA Type4X

- HA**  Cable entry: 2 x PG9 + 1 x M20.
HL  Cable entry: 2 x 1/2"NPT.
HM  Cable entry: 2 x M16 + 1 x M20.
HN  Cable entry: 1 x M20.
HO  Cable entry: 2 x M20.
HP  Cable entry: 6 x M12.
HT  Cable entry: 1 x 1/2"NPT.
HU  Cable entry: 3 x 1/2"NPT.
HV  Cable entry: 4 x M20.
HZ  Cable entry: no holes.

Digital output signals

- OA** Three active transistor outputs - requires PD, PF, PM or PX.
OR Two mechanical relay outputs + one OT or OA - requires PF or PM.
OS Four mechanical relay outputs - requires AP and PD.
OT  **Three passive transistor outputs - standard configuration.**

Power requirements

- PD**  8 - 24V AC / DC + sensor supply - with XI: 16 - 30V DC.
PF 24V AC / DC + sensor supply.
PL Input loop powered from sensor signal type "A" - requires AI and OT (not XI).
PM 115 - 230V AC + sensor supply.
PX  **Basic power supply 8 - 30V DC (no real sensor supply).**

Additional battery supply (optional)

- PB** Lithium battery powered - requires PD, PL or PX.
PC  Lithium battery powered - Intrinsically Safe - requires XI, and PD or PX.

Hazardous area

- XI**  Intrinsically Safe, according ATEX and IECEx.
XF Ex d enclosure - 3 keys according ATEX.
XX **Safe area only.**

Other options

- ZB** Backlight.
ZX  **No options.**

The bold marked text contains the standard configuration.

 Available Intrinsically Safe.

Specifications are subject to change without notice.



Quality
ISO 9001

www.dekra-seal.com

Fluidwell bv

P.O. Box 6
 5460 AA - Veghel - The Netherlands
 Telephone: +31 (0)413 343 786
 Telefax: +31 (0)413 363 443
 email: displays@fluidwell.com
 Internet: www.fluidwell.com

