



Air Mass Flow Sensor MCS100

The MCS100 is a compact, fast response air mass flow sensor equipped with Yamatake's original μ F (Micro Flow) sensor chip.

The MCS100 outputs mass flow signal according to the standard condition (20°C, 1 atm) of the gas flow without temperature nor pressure compensation.

The MCS100 offers a various flow range, in addition to its wide rangeability.

The MCS100 is suited for a variety of flow measurements in such as physics and industry applications.

- Compact and lightweight
33.5*10.5*17.0mm, just 9g (without cable)
- Fast response time
5ms max.
- High accuracy and high repeatability
Accuracy: \pm 5%FS, Repeatability: \pm 2.0%FS (depending on each model number)
- Positive/Negative flow measurement due to its symmetrical structure.
- Low power consumption
12mA max. at 24Vdc
- Free mounting position and not required straight piping

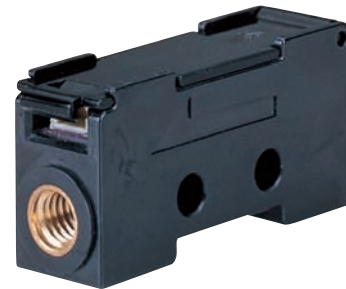

- length
- Typical applications
 - Air volume samplers
 - Gas analyzers
 - Pick and place detection for minute electronic/optical devices

■ Specifications

Model No.	MCS100A100	MCS100A104	MCS100A108	MCS100A112
Flow range	-3 to +3L/min	0 to 3L/min	-0.5 to +0.5L/min	0 to 0.5L/min
	Volume flow converted to the conditions of 20°C and 1 atm			
Applicable gas	Air and Nitrogen. Gas must be dry not containing any corrosive components (chlorine, sulfur, acid). The gas must also be free of any dust or oil mist.			
Response	5ms max. (95% response to a step state flow rate changing)			
Output signal	1 to 5Vdc (non-linear characteristics, refer to the standard output characteristics graph), allowable load resistance 10k Ω or more			
Operating temperature range	0 to 50°C (for both ambient temperature and gas temperature)			
Storage temperature	-10 to +60°C			
Operating humidity range	10 to 80%RH (no condensation allowed)			
Operating pressure range	-100 to +200kPa (Range for assured pressure characteristics: -70 to +200kPa)			
Pressure resistance	300kPa			
Measurement accuracy	\pm 5%FS max.	\pm 5%FS max.	\pm 5%FS max.	\pm 6%FS max.
	Output voltage 4V (5 to 1V) for full scale			
Typical characteristics of output voltage	0.0L/min: 3.00 \pm 0.15V 0.5L/min: 3.88 \pm 0.15V 1.5L/min: 4.49 \pm 0.15V 3.0L/min: 5.00 \pm 0.20V	0.0L/min: 1.00 \pm 0.20V 0.5L/min: 2.75 \pm 0.15V 1.5L/min: 3.97 \pm 0.24V 3.0L/min: 5.00 \pm 0.20V	0.0L/min: 3.00 \pm 0.20V 0.1L/min: 3.77 \pm 0.20V 0.3L/min: 4.53 \pm 0.20V 0.5L/min: 5.00 \pm 0.20V	0.0L/min: 1.00 \pm 0.24V 0.1L/min: 2.54 \pm 0.24V 0.3L/min: 4.06 \pm 0.24V 0.5L/min: 5.00 \pm 0.24V
	Full scale is to the output voltage 4V under the conditions of 20°C and 1 atm. (101.325kPa abs.)			
Repeatability	\pm 3.5%FS max.	\pm 7.0%FS max.	\pm 2.0%FS max.	\pm 2.0%FS max.
	Under the same temperature and pressure conditions. Output voltage 4V (5 to 1V) for full scale.			
Pressure characteristics	\pm 0.01%FS/kPa	\pm 0.02%FS/kPa	\pm 0.01%FS/kPa	\pm 0.02%FS/kPa
	Pressure range: -70 to +200kPa Full scale is to the output voltage 4V under the conditions of 20°C and 1 atm. (101.325kPa abs.).			

Model No.	MCS100A100	MCS100A104	MCS100A108	MCS100A112
Temperature characteristics	0.0L/min: $\pm 0.1\%FS/^{\circ}C$ 1.5L/min: $\pm 0.15\%FS/^{\circ}C$	0.0L/min: $\pm 0.1\%FS/^{\circ}C$ 1.5L/min: $\pm 0.15\%FS/^{\circ}C$	0.0L/min: $\pm 0.1\%FS/^{\circ}C$ 0.3L/min: $\pm 0.15\%FS/^{\circ}C$	0.0L/min: $\pm 0.2\%FS/^{\circ}C$ 0.3L/min: $\pm 0.2\%FS/^{\circ}C$
	Temperature range: 0 to 50°C Full scale is to the output voltage 4V under the conditions of 20°C and 1 atm. (101.325kPa abs.).			
Power supply voltage	12 to 24Vdc, Ripple: 5% max. at 12Vdc drive and 10% max. at 24Vdc drive. (Note 2)			
Power fluctuation range	When 12Vdc drive: $\pm 2\%FS$ max. to the output value at 12Vdc within the range of 11.4 to 13.2Vdc. When 24Vdc drive: $\pm 2\%FS$ max. to the output value at 24Vdc within the range of 21.6 to 26.4Vdc.			
Current consumption	12mA max. at 24Vdc			
Dielectric strength	500Vac (1 min) or 600V (1sec) between each external connector terminal and body			
Insulation resistance	50M Ω (500Vdc megger) between each external connector terminal and body			
Connection type	M5 female (brass insertion), tightening torque 2.5N·m max.			
Material	Parts exposed to gas: PPS resin, ceramic (printed wiring board) and brass (connecting part) Cover: PC (Polycarbonate) resin			
Mounting position	Free			
Mounting conditions	When using the mounting holes of body, use M3 screws and tighten with 0.6N·m max. torque. Install a filter in upstream side of this device to trap the dust or oil mist of 10 μ m or larger.			
Straight piping length	Not required for both upstream and down stream sides			
Vibration resistance	10 to 55Hz, 1.5mm peak-to-peak amplitude, 2 hours each in XYZ directions			
Weight (mass)	9g			
Electronic connection (Dedicated connector connection)	Cable with dedicated connector (sold separately) : 81446888-001 (2m), 81446888-002 (3m)			
	MCS side : SM03B-SRSS-G-TB manufactured by J.S.T.Mfg Co. Ltd., Counterpart side : SHR-03V-S-B (housing) and SSH-003GA-P.2 (contact) manufactured by the same company.			

Note 1: For the %FS in the above description, 4V of output voltage (1-5V) is specified as a full-scale.

Note 2: When used at 24Vdc drive, the output change may occur within $\pm 1\%FS$ max. after flowrate stabilization in the vicinity of measurement range upper limit flowrate (the amount of drift after 500s from the flowrate stabilization).

■ Standard flow rate characteristics

MCS100A100 [-3 to +3L/min]

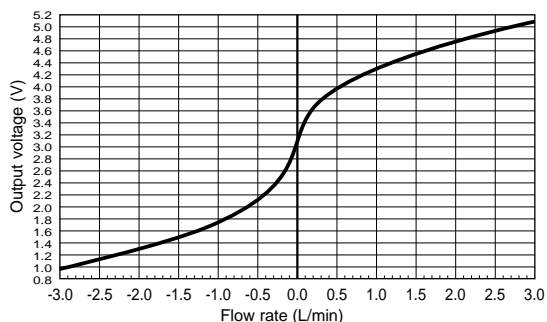

MCS100A108 [-0.5 to +0.5L/min]

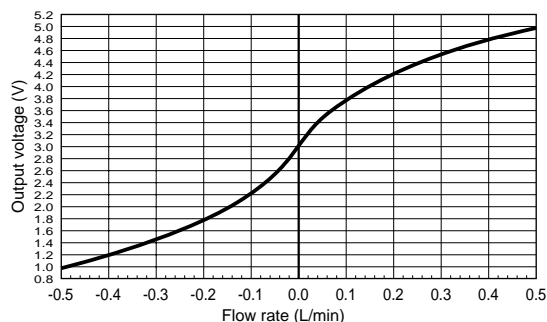

MCS100A104 [0 to 3L/min]

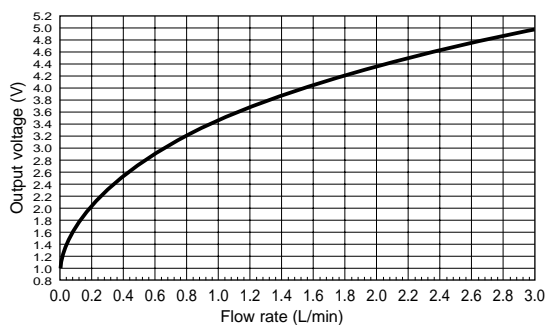

MCS100A112 [0 to +0.5L/min]

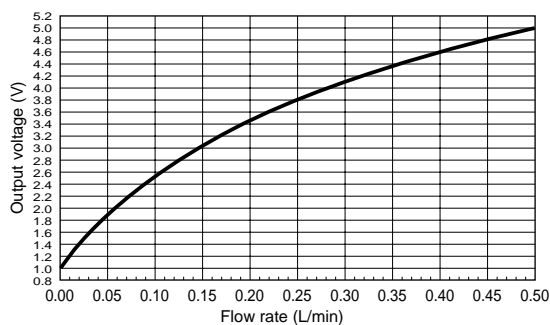

MCS100A100 output when outside valve "closed"
Flow rate +0.5 → 0L/min (95% response)

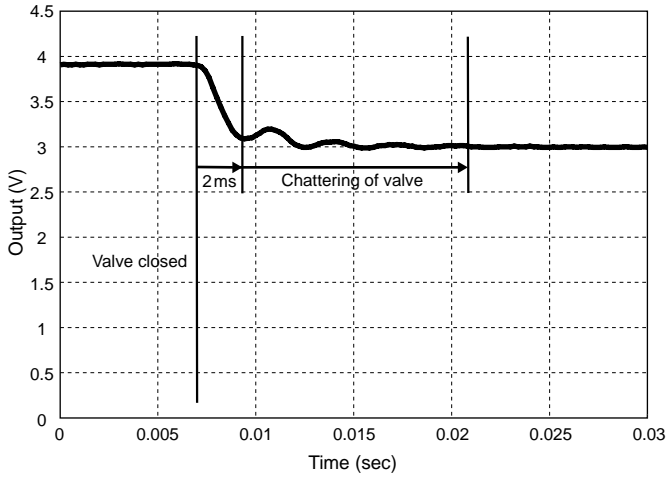

MCS100A100 output when outside valve "open"
Flow rate 0 → 0.5L/min (95% response)

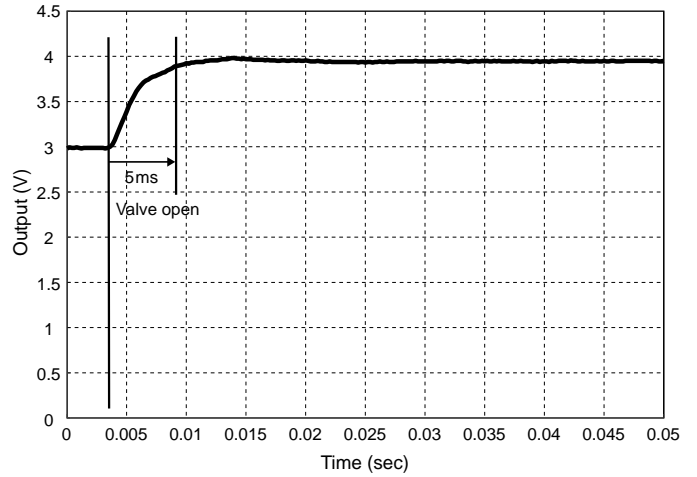

■ Connection

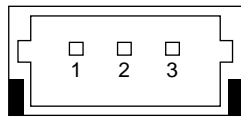

View from connector terminal side

Applicable connector:

Housing: SHR-03V-S-B
made by J.S.T. Mfg Co. Ltd.

Contact pin: SSH-003GA-P0.2
made by J.S.T. Mfg Co. Ltd.

Pin No.	Signal name	Description
1	V+	Power supply +
2	GND	GND
3	Vout	Sensor output

Note: Not insulated between inputs and outputs

Recommended connection example

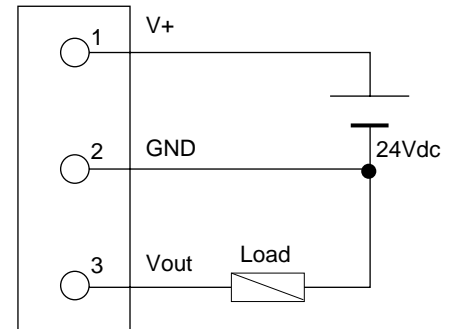

Note: Allowable load resistance is 10kΩ min.

■ Dimensions

(Unit: mm)

