

Member of the SmartPro® Family of Instruments



The 9950 Transmitter is a two channel controller that supports two sensors of same or different types in one instrument. The sensor types supported by the 9950 are Signet Flow, pH/ORP, Conductivity/Resistivity, Salinity, Temperature, Pressure, Level, Dissolved Oxygen, and devices that transmit a 4 to 20 mA signal with the use of the 8058 iGo® Signal Converter.

The 9950 includes advanced features such as derived functions, advanced multiple relay modes, and timer based relay functions. Derived functions allows for the control of a relay or current loop with the sum, delta (difference), or ratio of two measurements, for example delta pressure and delta temperature. Multiple relay modes allow up to three signals to be used for the control of a single relay. This can be any combination of analog and binary inputs. The timer relay modes allow a relay to be activated on a repeating basis from every minute to once every 30 days. Weekday timer mode allows a relay to be energized on a specific day or days of the week at a specific time.

The 3-9950.393-3 Relay Module includes the ability to interface up to four binary inputs. The binary inputs are compatible with either open collector or mechanical contacts. The binary inputs can supply power to the four inputs or accepts powered outputs from external devices. These inputs can be used with level switches, flow switches, pressure switches or other devices. The inputs can be used to directly control the relays of the 9950 or can be used in combination with the measurement readings for advanced control of your process.

The 9950 supports the following relay modules:

- Four Channel Mechanical Relay Module
- Two Mechanical and Two Solid State Relay Module
- Two Mechanical Relays and Four Binary Inputs Module

## Features

- One instrument for multiple sensor types
- Multiple language support for (Gen 2a) or later in Simplified Chinese, English, French, German and Spanish
- Two different sensor types can be combined in one instrument
- Configurable display
- Derived measurements
- Advanced boolean logic
- Optional modules can be added for additional capabilities
- Two, passive, 4 to 20 mA current loop outputs in base unit
- USB Port for Field Upgrades using standard USB Flash Drive



## Applications

- Wastewater Treatment
- Reverse Osmosis
- Deionization
- Chemical Manufacturing / Addition
- Metal and Plastic Finishing
- Fume Scrubber
- Cooling Tower
- Media Filtration
- Chemical Dosing/ Injection
- Aquatic Life Support
- Pools & Fountains
- Rinse Tanks
- Chemical Neutralization

# Specifications

General		
Input Channels	Two frequency or S <sup>3</sup> L inputs	
Enclosure and Display		
Case Material	PBT	
Window	Shatter-resistant glass	
Keypad	4 buttons, injection-molded silicone rubber seal	
Display	Dot matrix, LCD	
Indicators	Two horizontal digital bar graphs, four LED relay status indicators	
Update Rate	1 s	
LCD Contrast	5 settings	
Size	¼ DIN	
Mounting		
Panel	¼ DIN, ribbed on four sides for panel mounting clip inside panel, silicon gasket included	
Wall	Wall Mount enclosure (sold as an accessory)	
Terminal Blocks		
Pluggable Screw Type	Use minimum 105 °C rated wire	
Torque Ratings		
	Power/Loop	0.49 Nm (4.4 lb-in.)
	Freq/S <sup>3</sup> L	0.49 Nm (4.4 lb-in.)
	Relay Module	0.49 Nm (4.4 lb-in.)
Connector Wire Gauge		
	Power, Loop	12 to 28 AWG
	Freq/S <sup>3</sup> L	16 to 28 AWG
Relay Module Connector Wire Gauge		
	Relay	12 to 28 AWG
Environmental		
Ambient Operating Temperature		
DC Power	-10 °C to 70 °C	14 °F to 158 °F
AC Power	-10 °C to 60 °C	14 °F to 140 °F
Storage Temp	-15 °C to 70 °C	5 °F to 158 °F
Relative Humidity	0 to 100% condensing for (front only); 0 to 95% non-condensing (rear panel)	
Maximum Altitude	4,000 m (13,123 ft)	
Enclosure Rating	NEMA 4X/IP65 (front face only)	
Performance Specifications		
System Accuracy	Primarily dependent upon the sensor	
System Response	Primarily dependent upon the sensor. Controller adds a maximum of 150 ms processing delay to the sensor electronics.	
	Minimum update period is 100 ms	
	System response is tempered by the display rate, output averaging and sensitivity feature	

## Specifications (continued)

Electrical Requirements	
Power to Sensors	
Voltage	+4.9 to 5.5 VDC @ 25 °C, regulated
Current	30 mA Maximum
Short Circuit	Protected
Isolation	Low voltage (< 48 V AC/DC)
Power Requirements	
DC (3-9950-1, 3-9950-2)	24 VDC nominal (12 to 32 VDC, ±10% regulated), UL 60950-1 or UL 61010-1 Power Supply rated for operation at 4000 m altitude
AC (3-9950-2)	100 to 240 VAC, 50 to 60 Hz, 24 VA
Maximum current	200 mA (without optional relay module)*
	500 mA (with optional relay module)*
*The current draw of the other modules and the sensors are minimal	
Current Loop	12 to 32 VDC, ±10% regulated, 4 to 20 mA (30 mA max.)
Overvoltage protection	48 Volt Transient Protection Device (for DC ONLY)
Current limiting for circuit protection	
Reverse-Voltage protection	
Input Types	
Digital (S <sup>3</sup> L) or AC frequency	
4 to 20 mA input via the 8058 iGo Signal Converter	
Open collector	
pH/ORP input via the Digital (S <sup>3</sup> L) output from the 2750 pH/ORP Sensor Electronics or 2751 Smart pH/ORP Sensor Electronics	
Conductivity/Resistivity via the Digital (S <sup>3</sup> L) output from the 2850 Conductivity/Resistivity Sensor Electronics	
Sensor Types	Flow, pH/ORP, Conductivity/Resistivity, Pressure, Temperature, Level/Volume, Salinity, Dissolved Oxygen, Other (4 to 20 mA)
Sensor Input Specifications	
Digital (S <sup>3</sup> L)	Serial ASCII, TTL level, 9600 bps
Frequency Flow Sensors	0.5 to 1500 Hz
Sensitivity (for coil type sensors)	80 mV @ 5 Hz, gradually increasing with frequency to 2.5 V
Freq. Range (for square wave type sensors)	0.5 Hz to 1500 Hz @ TTL level input or open collector
K-Factor Range	0.0001 to 9999999
Accuracy	± 0.5% of reading max error @ 25 °C
Resolution	1 µs
Repeatability	± 0.2% of reading
Power Supply	
Rejection	No Effect ± 1 µA per volt
Short Circuit	Protected
Reverse Polarity	Protected
Update Rate	(1/frequency) + 100 ms

## Specifications (continued)

### Binary Input (3-9950.393-3)

Input Voltage Range (without damage)	-5 VDC to 30 VDC (No operation below 0 VDC)		
Max. Current Rating	6.0 mA		
Max. Voltage Rating	30 VDC		
Maximum Input Voltage for signal "Off" (low or "0")	1.5 VDC		
Minimum Input Voltage for signal "On" (high or "1")	3.0 VDC		
Maximum Current Draw for Signal "0" (low)	≤ 500 µA DC		
Minimum Current Draw for Signal "1" (high)	500 µA		
Typical Current Draw for Signal "1" (high)	6.0 mA at 30 VDC, 4.8 mA at 24 VDC, 2.4 mA at 12 VDC, 1.0 mA at 5 VDC		

### Current Loop Specifications

Current Loop Out	ANSI-ISA 50.00.01 Class H (Passive, external voltage required)		
Voltage	12 to 32 VDC, ±10% regulated, UL 60950-1 or UL 61010-1 Power Supply rated for operation at 4000 m altitude		
Max. Impedance	250 Ω @ 12 VDC	500 Ω @ 18 VDC	750 Ω @ 24 VDC
Span	3.8 to 21 mA		
Accuracy	± 32 µA max. error @ 25 °C @ 24 VDC		
Resolution	6 µA or better		
Temp. Drift	± 1 µA per °C		
Isolation	Low voltage (< 48 VAC/DC)		
Update Rate	100 mS nominal		
Zero	4.0 mA factory set; user programmable from 3.8 to 5.0 mA		
Full Scale	20.0 mA factory set; user programmable from 19.0 to 21.0 mA		
Power Supply Rejection	± 1 µA per V		
Actual Update Rate Determined by Sensor Type			
Short Circuit and Reverse Polarity Protected			
Adjustable Span, Reversible			
Error Condition	Selectable error condition 3.6 or 22 mA or None		
Test Mode	Increment to desired current (range 3.8 to 21.00 mA)		
Analog Outputs	2 Passive 4 to 20 mA Outputs in Base Unit		

### Relay Specifications

#### Dry-Contact Relays (3-9950.393-1, 3-9950.393-2, and 3-9950.393-3)

Type	SPDT
Form	C
Max. Voltage Rating	30 VDC or 250 VAC
Max. Current Rating	5 A resistive

#### Solid-State Relays (3-9950.393-2)

Type	SPDT
Form	C
Max. Voltage Rating	30 VDC or 30 VAC
Max. Current Rating	0.050 A resistive

Hysteresis	Adjustable (absolute in Engineering Units)
On Delay	9999.9 seconds (max)
Cycle Delay	99999 seconds (max)
Test Mode	Set On or Off
Maximum Pulse Rate	0 to 300 pulses/minute
Proportional Pulse	0 to 300 pulses/minute
Volumetric Pulse Width	0.1 to 3200 s
PWM Period	0.1 to 320 s

## Specifications (continued)

Display Ranges		
pH	-1.00 to 15.00 pH	
pH Temp.	-99 °C to 350 °C	-146 °F to 662 °F
ORP	-1999 to +1999.9 mV	
Flow Rate	-9999 to 99999 units per second, minute, hour or day	
Totalizer	0.00 to 99999999 units	
Conductivity	0.0000 to 99999 µS, mS, PPM and PPB (TDS), kΩ, MΩ	
Cond. Temp.	-99 °C to +350 °C	-146 °F to 662 °F
Temperature	-99 °C to +350 °C	-146 °F to 662 °F
Pressure	-40 to 1000 psi	
Level	-9999 to +99999 m, cm, ft, in, %	
Volume	0 to 99999 cm <sup>3</sup> , m <sup>3</sup> , in <sup>3</sup> , ft <sup>3</sup> , gal, L, lb, kg, %	
Salinity	0 to 100 PPT	
Dissolved Oxygen	0 to 50 mg/L, 0 to 200%	

Shipping Weights		
Base Unit	0.63 kg	1.38 lb
Relay Module	0.19 kg	0.41 lb

Standards and Approvals		
CE, UL, CUL, FCC		
RoHS Compliant, China RoHS		
Manufactured under ISO 9001 and ISO 14001 for Environmental Management and OHSAS 18001 for Occupational Health and Safety		

## Dimensions

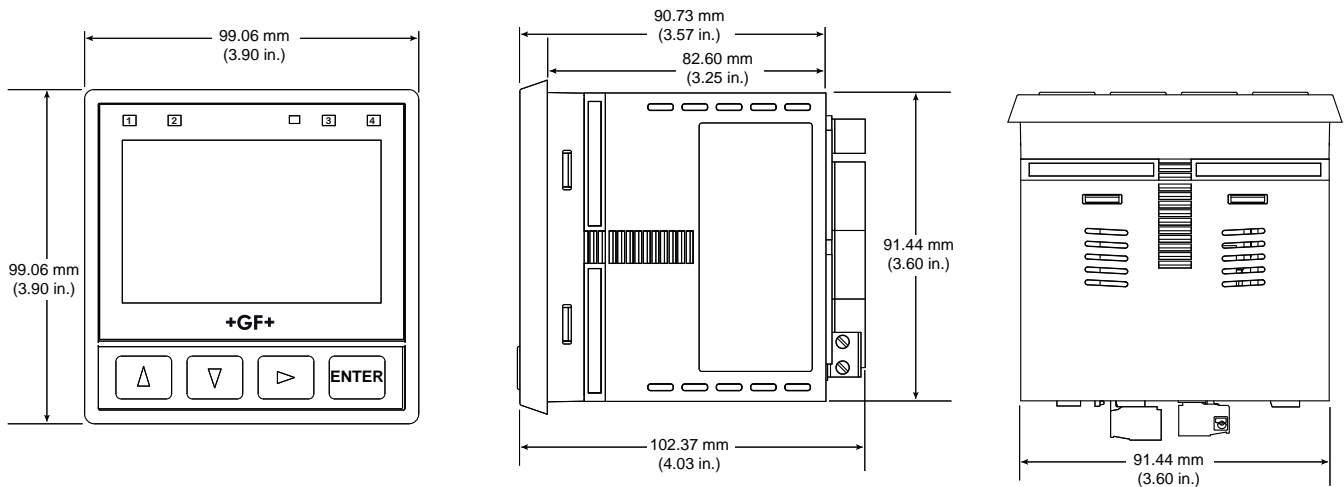

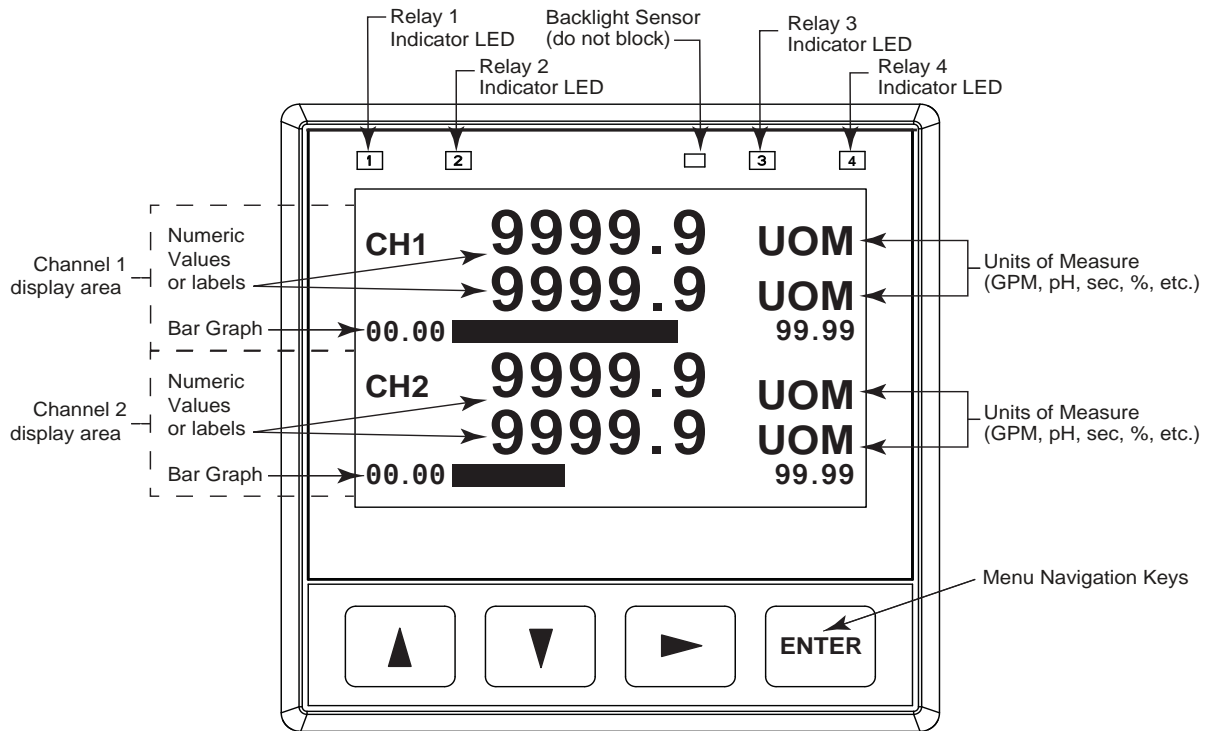

The 9950 is compatible with all GF Signet products listed in the column to the right.

- pH and ORP electrodes require the Signet 2750 or 2751 DryLoc® Sensor Electronics (sold separately).
- Conductivity/Resistivity or measurement requires the Signet 2850 Conductivity/Resistivity sensor electronics (sold separately).

Sensor Model	Freq Output	Digital (S <sup>3</sup> L) Output	Requires 8058
515/8510	X		
525	X		
2000	X		
2100	X		
2250		X	
2350		X	
2450		X	
2507	X		
2536/8512	X		
2537-5		X	
2540	X		
2551	X	X	
2552	X	X	
U1000	X		X
U3000	X		X
U4000	X		X
2260			X
2270			X
2290			X
2291			X
2610-41		X	
2724-2726		X	
2734-2736		X	
2750, 2751		X	
2756-2757		X	
2764-2767		X	
2774-2777		X	
2819-2823		X	
2839-2842		X	
2850		X	

Binary Input compatible sensors. For use with  
3-9950.393-3 Relay Module

Sensor Model	Binary Input
2280	X
2281	X
2282	X
2284	X
2285	X

System Overview

**Panel or Wall Mount**

**Signet Model 9950 Transmitter**  
(Includes mounting bracket and panel gasket)



---

Signet Sensors - Flow, Level, Temperature, Pressure, DO  
Use one input from sensor options below

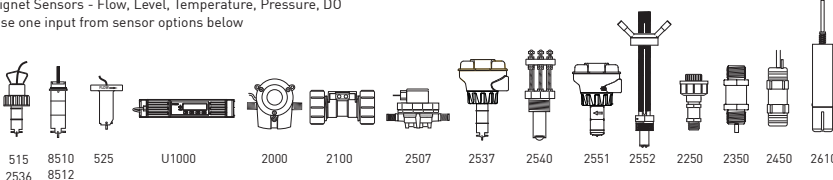

515 8510 525 U1000 2000 2100 2507 2537 2540 2551 2552 2250 2350 2450 2610

2536 8512

**Other Level with 8058 iGo Converter**  
plus other 4 to 20 mA

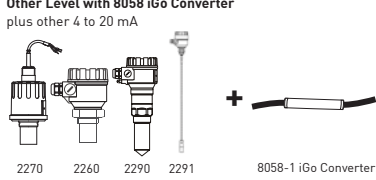

2270 2260 2290 2291 8058-1 iGo Converter

---

Signet Sensors - pH/ORP  
Use one input from sensor options below  
with 2750 or 2751 Sensor Electronics

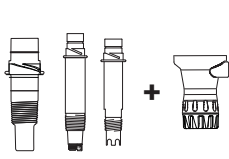

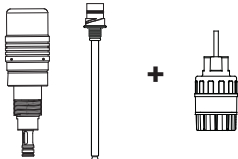
+ 

---

Signet Sensors - Conductivity/Resistivity and Salinity Electrodes  
Use one input from electrode options below  
with Conductivity Module or 2850 Sensor Electronics

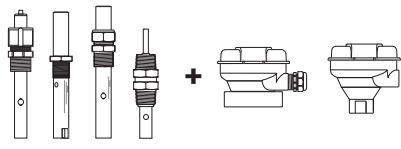

---

Signet Fittings - See individual sensor data sheets All sold separately

## Ordering Information

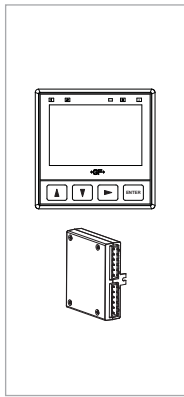

Mfr. Part No	Code	Description
9950 Base Unit - Dual Channel, Multi-Parameter, AC Power and DC Power		
3-9950-1	<b>159 001 841</b>	9950 Base Unit – Two Channel Multi-Parameter Inputs, Two 4 to 20 mA Outputs, Panel Mount, DC Power
3-9950-2	<b>159 001 842</b>	9950 Base Unit – Two Channel Multi-Parameter Inputs, Two 4 to 20 mA Outputs, Panel Mount, AC or DC Power
<b>Optional Accessory Modules</b>		
3-9950.393-1	<b>159 310 268</b>	Relay Module with 4 Mechanical Relays
3-9950.393-2	<b>159 310 269</b>	Relay Module with 2 Mechanical and 2 Solid State Relays
3-9950.393-3	<b>159 310 270</b>	Relay Module with 2 Mechanical Relays and 4 Binary Inputs

## Accessories and Replacement Parts

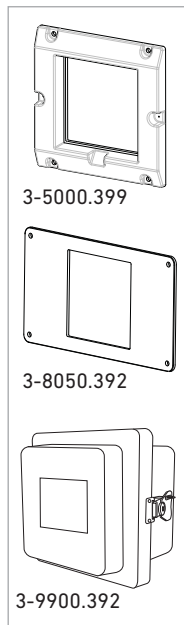

Mfr. Part No	Code	Description
3-5000.399	<b>198 840 224</b>	5 x 5 inch Retrofit Adapter
3-8050.392	<b>159 000 640</b>	CR200 ¼ DIN Retrofit Adapter
3-8050.396	<b>159 000 617</b>	RC Filter Kit (for relay use), 2 per kit
3-8058-1	<b>159 000 966</b>	i-Go® Signal Converter, wire-mount
3-9950.391	<b>159 310 278</b>	Connector Kit, In-Line, 9950 Transmitter
3-9950.392	<b>159 310 279</b>	Relay Module Connector Kit, 9950 Transmitter
3-9900.392	<b>159 001 700</b>	Wall Mount Enclosure Kit
3-9000.392-1	<b>159 000 839</b>	Liquid Tight Connector Kit, NPT (1 pc.)

3-9950.099 Rev C (05/17)

© Georg Fischer Signet LLC

3401 Aero Jet Avenue, El Monte, CA 91731-2882 U.S.A. • Tel. (626) 571-2770 • Fax (626) 573-2057 • www.gfsignet.com • e-mail: signet.ps@georgfischer.com

Specifications subject to change without notice. All rights reserved. All corporate names and trademarks stated herein are the property of their respective companies.