

Signet 8150 Battery Powered Flow Totalizer



Member of the ProcessPro® Family of Instruments



Panel Mount

Pipe, Wall, and Tank
Mount

Integral
Mount

The Signet 8150 Battery Powered Flow Totalizer is compatible with the Signet 515 and 525 flow sensors, and will provide years of dependable operation. The large digital display indicates flow rate and totalized flow volume simultaneously. One of the three totalizers is resettable from the front panel or a remote location, while the second resettable totalizer can only be reset by entering a user-selectable security code. The third is a permanent non-resettable totalizer.

Our intuitive software design and four-button keypad provide for simple operation while setting screen displays and programming the system. Calibration can be easily performed by entering the AutoCal feature and entering a value to match an external reference. Screen displays can be modified to suit the user's needs; along with the flow rate, any of the three totalizers can be selected as the displayed totalizer. Users can quickly scroll through the totalizers simply by pressing any key on the keypad. A display averaging feature is included for applications where the flow in the pipe fluctuates. For applications where flow stops and starts due to production needs, a no-flow indicator will display the hours of non-flow.

Features

- Three totalizers: 2 resettable and 1 permanent, user-selectable
- Long-lasting lithium batteries
- Mounting versatility
- No-flow indicator
- Large digital display with averaging
- Simple push-button operation
- User-selectable access code prevents unwanted changes
- Auto-calibration



Applications

- Wastewater Flow Accumulation
- Water Treatment Systems
- Remote or Mobile Treatment/
Distribution Systems
- Irrigation Systems
- Filtration Systems
- Commercial Pools & Spas
- Groundwater Remediation
- R.O. Concentrate
- Process Flow Monitoring
- UPW Distribution
- Demineralizer Regeneration
- Process Cooling Water

Specifications

General		
Compatibility	Signet 515 and 525 flow sensors	
Input Freq. Range	0 to 400Hz	
Accuracy	±0.5% of reading	
Display	LCD type	
	4-digit upper line - flow rate	
	8-digit lower line - volume totalizer count, either resettable or permanent	
Averaging	0 to 120 secs.	
Contrast	Automatic	
Low Battery Indication	Battery symbol appears on LCD display	
8-digit Resettable Totalizers	Stored until user resets; continues to be stored even after batteries are removed	
8-digit Permanent	Kept permanently, even when batteries are removed	
Materials		
Enclosure	PBT resin	
Keypad	Sealed 4-key silicon rubber	
Panel and Case Gasket	Neoprene	
Window	Polyurethane coated polycarbonate	
Electrical		
Battery	Two 3.6 V Lithium thionyl chloride, AA-size	
Battery Life	4 years nominal @ 50 °C (122 °F)	
Environmental		
Operating Temperature	-10 °C to 65 °C	14 °F to 149 °F
	-40 °C to 100 °C	-40 °F to 212 °F
Relative Humidity	0 to 95%, non-condensing	
Enclosure	NEMA 4X/IP65 (front face only on panel mount); field mount is 100% NEMA 4X/IP65	
Shipping Weight		
	0.5 kg	1.1 lb
Standards and Approvals		
	CE, FCC, UL, CUL	
	RoHS compliant, China RoHS	
	Manufactured under ISO 9001 for Quality and ISO 14001 for Environmental Management and OHSAS 18001 for Occupational Health and Safety	

Dimensions

3-8150-1P

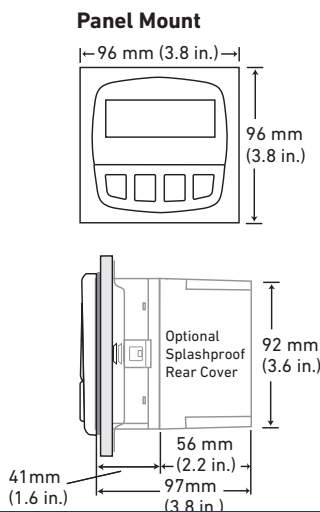

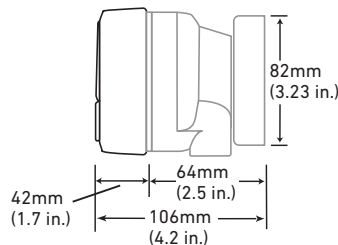

3-8150-1 with Universal Mount

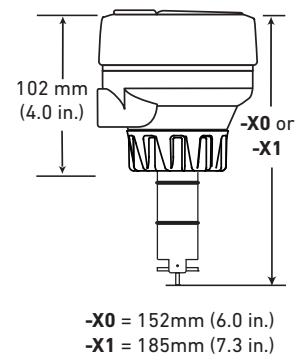

Model 515 Integral Mount Sensors - see 515 data sheet for specifications

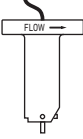
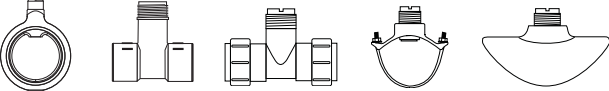

System Overview

	Panel Mount	Pipe, Tank, Wall Mount
Signet 8150 Flow Totalizer includes mounting bracket and panel gasket		Signet 8150 Flow Totalizer with 3-8050 Universal Mount Kit 
Signet Sensors 515 525		
Signet Fittings		
	All sold separately	

Ordering Notes

- 1) For panel version, cutout must be 92 x 92 mm (3.62 x 3.62 in.)
- 2) To mount the panel version on a wall, use the heavy duty wall mount bracket.
- 3) Use the Universal mounting kit with the field mount instrument to mount to a pipe, tank or wall.
- 4) An optional splashproof rear cover can be ordered separately if needed.

Please refer to Wiring, Installation, and Accessories sections for more information.

Ordering Information

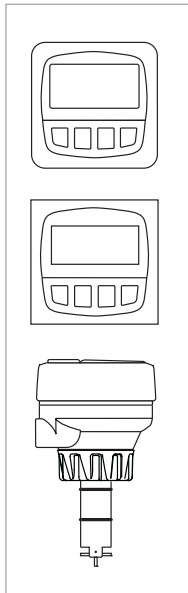

Mfr. Part No.	Code	Mounting notes
Battery Operated Flow Totalizer		
Field Mount (yellow body)		
3-8150-1	159 000 929	Field mount for pipe, tank, and wall mounting
Panel Mount (black body)		
3-8150-1P	159 000 930	Panel mount; includes mounting bracket and panel gasket
Integral Mount		
for ½ to 4 in. pipes		
3-8150-P0*	159 000 931	mounted on Model 515 Paddlewheel (Part No. 3-8510-P0), w/polypropylene body, black polypropylene retaining nut, black PVDF rotor, and Titanium pin
3-8150-T0*	159 001 011	mounted on Model 515 Paddlewheel (Part No. 3-8510-T0), with a natural PVDF body, natural PVDF retaining nut, rotor, and pin
for 5 to 8 in. pipes		
3-8150-P1*	159 000 932	mounted on Model 515 Paddlewheel (Part No. 3-8510-P1), w/polypropylene body, black polypropylene retaining nut, black PVDF rotor, and Titanium pin

* See individual sensor sheets for more sensor information.

Accessories and Replacement Parts

Mfr. Part No.	Code	Description
Mounting		
3-8050	159 000 184	Universal mounting kit
3-8050.390-1	159 001 702	Retaining nut replacement kit, NPT, Valox
3-8050.390-3	159 310 116	Retaining nut replacement kit, NPT, PP
3-8050.390-4	159 310 117	Retaining nut replacement kit, NPT, PVDF
3-0000.596	159 000 641	Heavy duty wall mount bracket (panel mount only)
3-5000.399	198 840 224	Panel adapter, 5 x 5 in. to ¼ DIN
3-5000.598	198 840 225	Surface mount bracket (panel mount only)
3-8050.395	159 000 186	Splashproof rear cover (panel mount only)
3-9900.396	159 001 701	Angle adjustment adapter kit
Liquid Tight Connectors		
3-9000.392	159 000 368	Liquid tight connector kit (includes 3 connectors)
3-9000.392-1	159 000 839	Liquid tight connector, NPT (1 connector)
3-9000.392-2	159 000 841	Liquid tight connector, PG 13.5 (1 connector)
Other		
7400-0011	159 000 935	Lithium battery, 3.6 V, size AA (2 required)
5523-0222	159 000 392	Cable (per foot), 2 cond. w/shield, 22 AWG
Replacement Parts for Integral Mount Units - see Model 515 catalog pages for information		
3-8051	159 000 187	Flow integral mounting kit, NPT, Valox
3-8051-1	159 001 755	Flow integral mounting kit, NPT, PP
3-8051-2	159 001 756	Flow integral mounting kit, NPT, PVDF
3-8510-P0	198 864 504	Sensor for ½ to 4 in. pipes, Polypropylene body
3-8510-PI	198 864 505	Sensor for 5 to 8 in. pipes, Polypropylene body
3-8510-T0	159 000 622	Sensor for ½ to 4 in. pipes, all natural PVDF
3-8510-V0	198 864 506	Sensor for ½ to 4 in. pipes, PVDF body

ICENTA



Icenta Controls Ltd
 Unit 3 The Woodford Centre Lysander Way, Old Sarum Park
 Salisbury Wiltshire UK
 SP4 6BU