

#### Overview



The SITRANS F M MAG 3100 is an electromagnetic flow sensor in a large variety that meets the demands of almost every flow application.

#### Benefits

- Wide range of sizes: DN 15 to DN 2000 (½" to 78")
- The flexible design is for all applications not covered by the standard industry-specific sensors: MAG 1100, MAG 1100 F, MAG 3100 P and MAG 5100 W
- Wide pressure range: PN 6 to PN 100 ANSI Class 150/300, AS 2129, AS 4087, JIS K10 and K20. On request up to 690 bar (10 000 psi)
- Wide range of electrode and liner material to fit even the most extreme process media
- Fully welded construction provides a ruggedness that suits the toughest applications and environments
- Easy commissioning, the SENSORPROM unit automatically updates settings.
- Designed to allow patented SITRANS F M in-situ verification using the SENSORPROM fingerprints.

#### Application

The main applications of the SITRANS F M electromagnetic flow sensors can be found in the following fields:

- Process industry
- Chemical industry
- Steel industry
- Mining
- Utility
- Power generation and distribution
- Oil and gas / HPI
- Water and waste water

#### Design

- Compact or remote mounting possible
- Easy "plug & play" field changeability of transmitter
- Ex ATEX and FM/CSA versions
- High temperature sensor for applications with temperatures up to 180 °C (356 °F)
- Approvals for PTB and OIML R 117
- Meets EEC directives: PED, 97/23/EC pressure directive for EN1092-1 flanges
- Build-in length according to ISO 13359, the standard includes sizes up to DN 400
- Onsite or factory upgrade to IP68/NEMA 6P of a standard sensor.

#### Mode of operation

The flow measuring principle is based on Faraday's law of electromagnetic induction according to which the sensor converts the flow into an electrical voltage proportional to the velocity of the flow.

#### Integration

The complete flowmeter consists of a flow sensor and an associated transmitter MAG 5000, 6000 and 6000 I.

The flexible communication concept USM II simplifies integration and update to a variety of fieldbus systems such as HART, FOUNDATION Fieldbus H1, DeviceNet, PROFIBUS DP and PA, Modbus RTU/RS 485.

# Flow Measurement SITRANS F M

## Flow sensor MAG 3100 and MAG 3100 HT

**Pressure/temperature curve;  
material AISI 316L/1.4404 AS 2129, Class E**

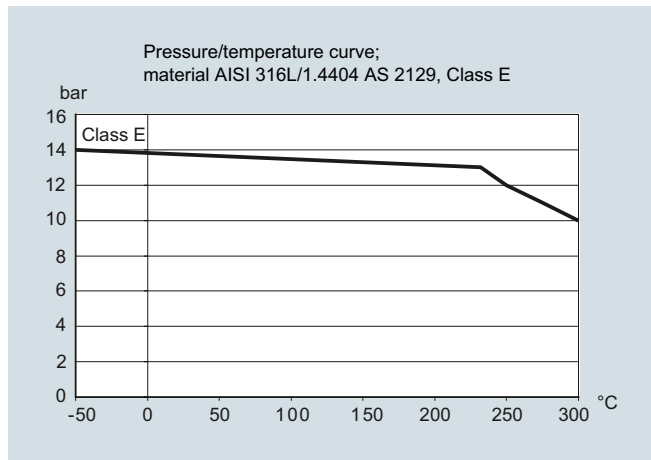

**Pressure/temperature curve - JIS 2200**

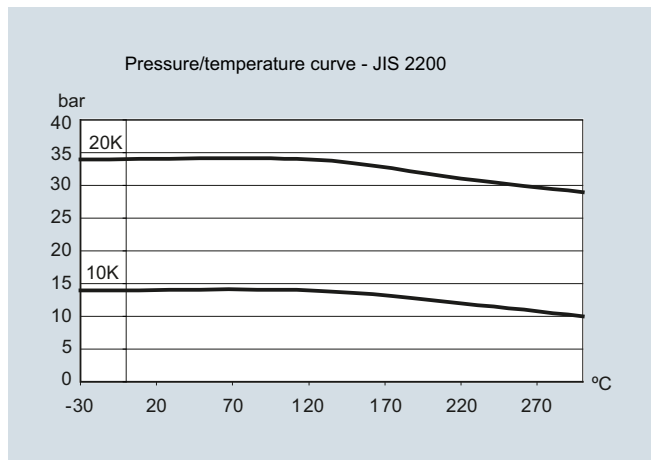

**Pressure/temperature curve to EN (DIN) flanges,  
material A 105 carbon steel**

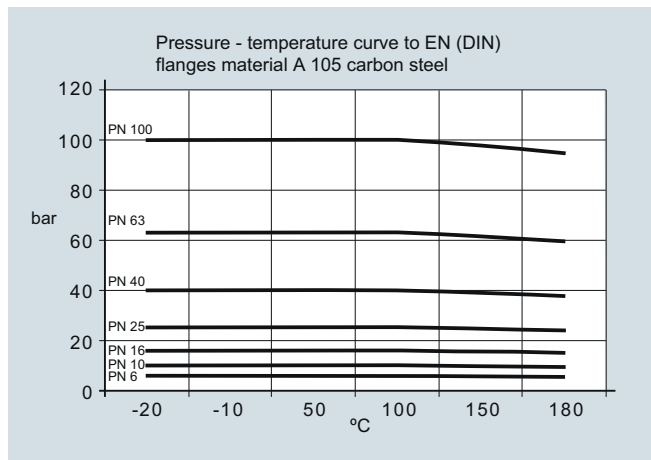

**Pressure/temperature curve to EN (DIN) flanges AISI 304**

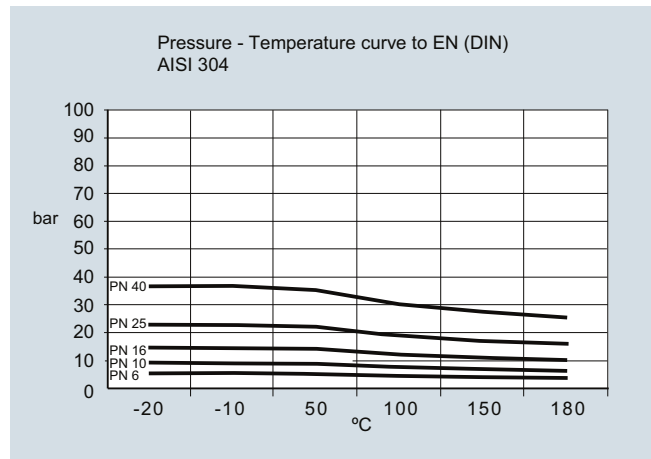

**Pressure/temperature curve to EN (DIN) flanges AISI 316**

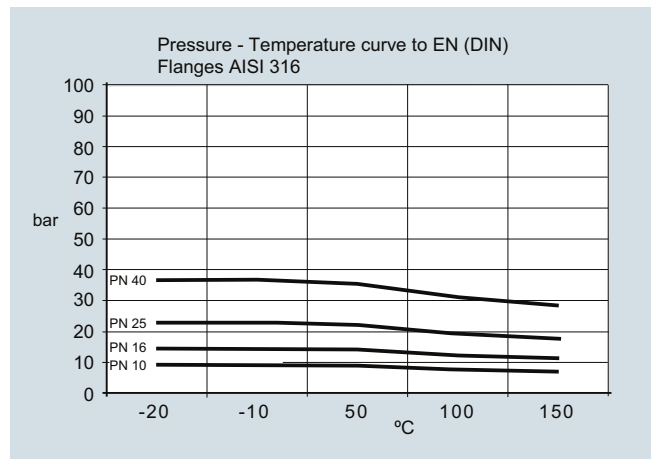

**Pressure/temperature curve to ANSI B16.5 flanges**

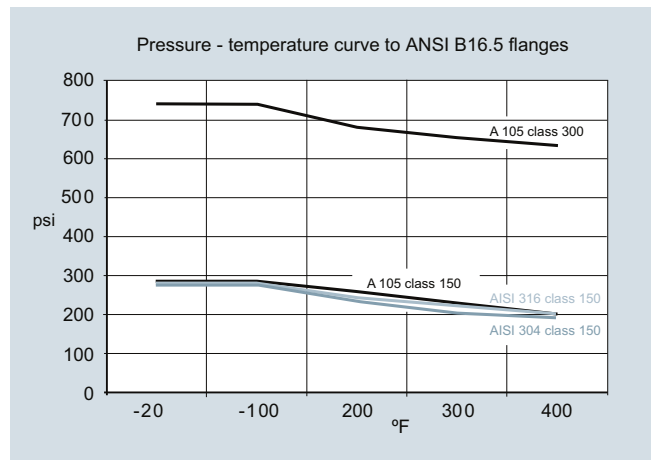

**Note:** The pressure-temperature curves only assist in the selection of a system. No responsibility is taken for the correctness of the information. For further information on the PED standard and requirements, see page 9/6.

#### Technical specifications

Version	MAG 3100	MAG 3100 HT (High Temperature)
<b>Product characteristic</b>	Flexible product program	Flexible product program
Nominal size	DN 15 ... DN 2000 (½" ... 78")	DN 15 ... DN 300 (½" ... 12")
Measuring principle	Electromagnetic induction	Electromagnetic induction
Excitation frequency (Mains supply: 50 Hz/60 Hz)	<ul style="list-style-type: none"> <li>• DN 15 ... 65 (½" ... 2½"): 12.5 Hz/15 Hz</li> <li>• DN 80 ... 150 (3" ... 6"): 6.25 Hz/7.5 Hz</li> <li>• DN 200 ... 1200 (8" ... 48"): 3.125 Hz/3.75 Hz</li> <li>• DN 1400 ... 2000 (54" ... 78"): 1.5625 Hz/1.875 Hz</li> </ul>	<ul style="list-style-type: none"> <li>• DN 15 ... 65 (½" ... 2½"): 12.5 Hz/15 Hz</li> <li>• DN 80 ... 150 (3" ... 6"): 6.25 Hz/7.5 Hz</li> <li>• DN 200 ... 300 (8" ... 12"): 3.125 Hz/3.75 Hz</li> </ul>
<b>Process connection</b>		
Flanges	<p>EN 1092-1, raised face<sup>1)</sup> (EN 1092-1, DIN 2501 and BS 4504 have the same mating dimensions)</p> <ul style="list-style-type: none"> <li>• DN 65 ... 2000 (2½" ... 78"): PN 6 (87 psi)</li> <li>• DN 200 ... 2000 (8" ... 78"): PN 10 (145 psi)</li> <li>• DN 65 ... 2000 (2½" ... 78"): PN 16 (232 psi)</li> <li>• DN 200 ... 600 (8" ... 24"): PN 25 (362 psi)</li> <li>• DN 15 ... 600 (½" ... 24"): PN 40 (580 psi)</li> <li>• DN 50 ... 300 (2" ... 12"): PN 63 (913 psi)</li> <li>• DN 25 ... 300 (1" ... 12"): PN 100 (1450 psi)</li> </ul> <p>ANSI B16.5 (~BS 1560), raised face</p> <ul style="list-style-type: none"> <li>• ½" ... 24": Class 150 (20 bar (290 psi))</li> <li>• ½" ... 24": Class 300 (50 bar (725 psi))</li> </ul> <p>AWWA C-207, flat face 28" ... 78": Class D (10 bar)</p> <p>AS 2129, raised face ½" ... 48": Table E</p> <p>AS 4087, raised face:</p> <ul style="list-style-type: none"> <li>• PN 16 (DN 50 ... 1200, 16 bar (232 psi))</li> <li>• PN 21 (DN 50 ... 600, 21 bar (304 psi))</li> <li>• PN 35 (DN 50 ... 600, 35 bar (508 psi))</li> </ul> <p>JIS B 2220:2004</p> <ul style="list-style-type: none"> <li>• K10 (1" ... 24")</li> <li>• K20 (1" ... 24")</li> </ul> <p>Other flanges and pressure ratings on request</p>	<p>EN 1092-1, raised face (EN 1092-1, DIN 2501 and BS 4504 have the same mating dimensions)</p> <ul style="list-style-type: none"> <li>• DN 15 ... 300 (½" ... 12"): PN 40 (580 psi)</li> <li>• DN 65 ... 300 (2½" ... 12"): PN 16 (232 psi)</li> <li>• DN 200 ... 300 (8" ... 12"): PN 10 (145 psi)</li> <li>• DN 200 ... 300 (8" ... 12"): PN 25 (362 psi)</li> </ul> <p>ANSI B16.5 (~BS 1560), raised face:</p> <ul style="list-style-type: none"> <li>• ½" ... 12": Class 150 (20 bar (290 psi))</li> <li>• ½" ... 12": Class 300 (50 bar (725 psi))</li> </ul> <p>AS 2129, raised face ½" ... 12": Table E</p> <p>Other flanges and pressure ratings on request</p>
<b>Rated operation conditions</b>		
<b>Ambient temperature</b> (conditions also dependent on liner characteristics)		
<ul style="list-style-type: none"> <li>• Standard sensor</li> <li>• Ex sensor</li> </ul>	<p>-40 ... +100 °C (-40 ... +212 °F)</p> <p>-20 ... +60 °C (-4 ... +140 °F)</p>	<p>-40 ... +100 °C (-40 ... +212 °F)</p> <p>For medium temperature up to 150 °C (302 °F): -20 ... +60 °C (-4 ... +140 °F)</p> <p>For medium temperature 150 ... 180 °C (302 ... 356 °F): -20 ... +50 °C (-4 ... +122 °F)</p>
<ul style="list-style-type: none"> <li>• With compact transmitter <ul style="list-style-type: none"> <li>- MAG 5000/6000<sup>2)</sup></li> <li>- MAG 6000 I</li> <li>- MAG 6000 I Ex</li> </ul> </li> </ul>	<p>-20 ... +60 °C (-4 ... +140 °F)</p> <p>-20 ... +60 °C (-4 ... +140 °F)</p> <p>-20 ... +60 °C (-4 ... +140 °F)</p>	<p>-20 ... +60 °C (-4 ... +140 °F)</p> <p>-20 ... +60 °C (-4 ... +140 °F)</p> <p>-20 ... +60 °C (-4 ... +140 °F)</p>

# Flow Measurement

## SITRANS F M

### Flow sensor MAG 3100 and MAG 3100 HT

Version	MAG 3100	MAG 3100 HT (High Temperature)
Operating pressure [abs. bar] (maximum operating pressure decreases with increasing operating temperature and with stainless steel flanges)	<ul style="list-style-type: none"> <li>Soft rubber 0.01 ... 100 bar (0.15 ... 1450 psi)</li> <li>EPDM 0.01 ... 40 bar (0.15 ... 580 psi)</li> <li>Linatex 0.01 ... 40 bar (0.15 ... 580 psi)</li> <li>Ebonite 0.01 ... 100 bar (0.15 ... 1450 psi)</li> <li>PTFE               <ul style="list-style-type: none"> <li>- DN ≤ 300 (≤ 12"): 0.3 ... 50 bar (4 ... 725 psi)</li> <li>- 350 ≤ DN ≤ 600 (14" ≤ DN ≤ 24"): 0.3 ... 40 bar (4 ... 580 psi)</li> </ul> </li> <li>PFA               <ul style="list-style-type: none"> <li>- DN 15 ... 150 (½" ... 6"): Vacuum 0.02 ... 50 bar (0.29 ... 725 psi)</li> </ul> </li> </ul>	<ul style="list-style-type: none"> <li>PTFE Teflon               <ul style="list-style-type: none"> <li>- DN 15 ... 300 (½" ... 12") (130/180 °C (266 °F/356°F)): 0.3/0.6 ... 50 bar (4/8 ... 725 psi) (180 °C (356 °F))</li> <li>PTFE has factory mounted grounding SS rings type E and SS terminal box)</li> </ul> </li> <li>PFA               <ul style="list-style-type: none"> <li>- DN 15 ... 150 (½" ... 6"): Vacuum 0.02 ... 50 bar (0.29 ... 725 psi)</li> </ul> </li> </ul>
Enclosure rating	IP67 to EN 60529/NEMA 4X/6, 1 mH <sub>2</sub> O for 30 min Option: IP68 to EN 60529/NEMA 6P, 10 mH <sub>2</sub> O cont. (not for Ex)	IP67 to EN 60529/NEMA 4X/6, 1 mH <sub>2</sub> O for 30 min Option: IP68 to EN 60529/NEMA 6P, 10 mH <sub>2</sub> O cont. (not for Ex)
Pressure drop at 3 m/s	As straight pipe	
Test pressure	1.5 x PN (where applicable)	
Mechanical load (vibration)	<ul style="list-style-type: none"> <li>18 ... 1000 Hz random in x, y, z, directions for 2 hours according to EN 60068-2-36</li> <li>Sensor: 3.17 grms</li> <li>Sensor with compact MAG 5000/ 6000 mounted transmitter: 3.17 grms</li> <li>Sensor with compact MAG 6000 I/ 6000 I Ex mounted transmitter: 1.14 grms</li> </ul>	<ul style="list-style-type: none"> <li>18 ... 1000 Hz random in x, y, z, directions for 2 hours according to EN 60068-2-36</li> <li>Sensor: 3.17 grms</li> <li>Sensor with compact MAG 5000/ 6000 mounted transmitter: 3.17 grms</li> <li>Sensor with compact MAG 6000 I/ 6000 I Ex mounted transmitter: 1.14 grms</li> </ul>
Temperature of medium	<ul style="list-style-type: none"> <li>Soft rubber 0 ... +70 °C (32 ... 158 °F)</li> <li>EPDM -10 ... +70 °C (14 ... 158 °F)</li> <li>Linatex (rubber) -40 ... +70 °C (-40 ... +158 °F) (for temperatures below -20 °C (-4 °F) AISI 304 or 316 flanges must be used)</li> <li>Ebonite 0 ... 95 °C (32 ... 203 °F)</li> <li>PTFE -20 ... +100 °C (-4 ... +212 °F)</li> <li>PFA -20 ... +100 °C (-4 ... +212 °F)</li> </ul>	<ul style="list-style-type: none"> <li>PTFE -20 ... +130 °C (-4 ... +266 °F)</li> <li>PTFE -20 ... +180 °C (-4 ... +356 °F) Factory mounted grounding rings type E in SS and SS terminal box. Can only be used with remote transmitter.</li> <li>PFA -20 ... +150 °C (-4 ... +300 °F)</li> </ul>
EMC	2004/108/EC	2004/108/EC
<b>Design</b>	See dimensional drawings	
Weight	See dimensional drawings	
Flange and housing material	Carbon steel ASTM A 105, with corrosion resistant two component epoxy coating (min. 150 µm) or Stainless steel AISI 304/1.4301 flanges and carbon steel housing, with corrosion resistant two component epoxy coating (min. 150 µm) or Stainless steel AISI 316L/1.4404 flanges and housing, polished	Carbon steel ASTM A 105, with corrosion resistant two component epoxy coating (min. 150 µm) or AISI 304/1.4301 flanges and carbon steel housing, with corrosion resistant two component epoxy coating (min. 150 µm) or AISI 316L/1.4404 flanges and housing, polished
Measuring pipe material	Stainless steel AISI 304/1.4301	AISI 304/1.4301
Electrode material	<ul style="list-style-type: none"> <li>Stainless steel AISI 316Ti/1.4571</li> <li>Hastelloy C276/2.4819 (PFA: Hastelloy C22/2.4602)</li> <li>Platinum/Iridium</li> <li>Titanium</li> <li>Tantalum</li> </ul>	<ul style="list-style-type: none"> <li>AISI 316Ti/1.4571</li> <li>Hastelloy C276/2.4819 (PFA: Hastelloy C22/2.4602)</li> <li>Platinum/Iridium</li> <li>Titanium</li> <li>Tantalum</li> </ul>
Grounding electrode material	<ul style="list-style-type: none"> <li>Soft rubber, EPDM, Linatex, Ebonite: available with measuring electrodes in stainless steel AISI 316Ti/1.4571 or Hastelloy</li> <li>PTFE: none</li> <li>PFA: optional in Hastelloy, Tantalum or Platinum</li> </ul>	<ul style="list-style-type: none"> <li>PTFE: none</li> <li>PFA: optional in Hastelloy, Tantalum or Platinum</li> </ul>

Version	MAG 3100	MAG 3100 HT (High Temperature)
<b>Design (continued)</b>		
Terminal box (remote version only)	<ul style="list-style-type: none"> <li>Standard fibre glass reinforced polyamide</li> <li>Option Stainless steel AISI 316/1.4436</li> <li>Ex Stainless steel AISI 316/1.4436</li> </ul>	<ul style="list-style-type: none"> <li>Standard fibre glass reinforced polyamide (max. 150 °C (302 °F))</li> <li>Stainless steel AISI 316/1.4436</li> <li>Ex Stainless steel AISI 316/1.4436</li> </ul>
Cable entries	<ul style="list-style-type: none"> <li>Remote installation 2 x M20 or 2 x ½" NPT</li> <li>Compact installation               <ul style="list-style-type: none"> <li>MAG 5000/MAG 6000: 4 x M20 or 4 x ½" NPT</li> <li>MAG 6000 I: 2 x M25 or 2 x ½" NPT (for supply/output)</li> <li>MAG 6000 I Ex: 2 x M25 or 2 x ½" NPT (for supply/output)</li> </ul> </li> </ul>	<ul style="list-style-type: none"> <li>Remote installation 2 x M20 or 2 x ½" NPT</li> </ul>
<b>Certificates and approvals</b>		
Calibration		
Standard production calibration, calibration report shipped with sensor	Zero-point, 2 x 25 % and 2 x 90 % (default)	Zero-point, 2 x 25 % and 2 x 90 % (default)
Conforms to	PED (All EN1092-1 flanges conforms to PED) – 97/23/EC <sup>3)</sup> CRN	PED (All EN1092-1 flanges conforms to PED) – 97/23/EC <sup>3)</sup> CRN
Material certificate EN 10204-3.1	On request	On request
Ex approvals	<p>Ex sensors</p> <ul style="list-style-type: none"> <li>ATEX 2 GD DN 15 ... 300: EEx d e ia IIC T4 - T6</li> <li>DN 350 ... 2000: EEx e ia IIC T4 - T6</li> <li>IEC Ex de ia IIC T3-T6</li> <li>FM Class I, Div 1<sup>4)</sup></li> <li>FM Class I, Zone 1</li> <li>CSA Class I, Zone 1</li> </ul> <p>Standard sensors</p> <ul style="list-style-type: none"> <li>FM Class I, Div 2/Zone 2</li> <li>CSA Class I, Div 2/Zone 2</li> </ul>	<p>Ex sensors</p> <ul style="list-style-type: none"> <li>ATEX 2 GD DN 15 ... 300: EEx d e ia IIC T3 - T6</li> <li>IEC Ex de ia IIC T3-T6</li> <li>FM Class I, Div 1<sup>4)</sup></li> <li>FM Class I, Zone 1</li> <li>CSA Class I, Zone 1</li> </ul> <p>Standard sensors</p> <ul style="list-style-type: none"> <li>FM Class I, Div 2/Zone 2</li> <li>CSA Class I, Div 2/Zone 2</li> </ul>
Drinking water approvals	<p>EPDM lining:</p> <ul style="list-style-type: none"> <li>WRAS (WRc, BS690 cold water, GB)</li> <li>NSF/ANSI Standard 61<sup>5)</sup> (Cold water, US)</li> <li>ACS listed (F)</li> <li>DVGW W270 (D)</li> <li>Belgaqua (B)</li> <li>MCERTS (GB) (EPDM or PTFE lining with AISI 316 or Hastelloy electrodes)</li> </ul>	
Custody transfer (CT) (≤ DN2000) (only together with MAG 5000/6000 CT), order as special	<p>Cold water pattern approval - DANAK TS 22.36.001, PTB (Denmark and Germany)</p> <p>Hot water pattern approval - PTB (Germany)</p> <p>Other media than water - OIML R 117 (Denmark)</p>	Hot water pattern approval - PTB (Germany)

Technical specification for transmitter - see transmitter pages.

<sup>1)</sup> PN 6-40: DN ≤ 600 type 01 (SORF); DN > 600 type 11 (WNRf); PN 63-100: type 11 (WNRf)

<sup>2)</sup> With compact transmitter MAG 5000 CT/6000 CT -20 ... +50 °C (-4 ... +122 °F).

<sup>3)</sup> For sizes larger than 600 mm (24") in PN 16 PED conformity is available as a cost-added option. The basic unit will carry the LVD (Low Voltage Directive) and EMC approval. All products sold outside of EU and EFTA are excluded from the Pressure Equipment directive, also products sold into certain market sectors are excluded. These include:

a) Meters used in networks for the supply, distribution and discharge of water.

b) Meters used in pipelines for the conveyance of any fluid from offshore to onshore.

c) Meters used in the extraction of petroleum or gas, including christmas tree and manifold equipment.

d) Any meter mounted on a ship or mobile offshore platform. For further information on the PED standard and requirements see page 9/6.

<sup>4)</sup> Only with sensors sizes DN 15 ... 300 (½" ... 12") compact.

<sup>5)</sup> Including Annex G

# Flow Measurement

## SITRANS F M

### Flow sensor MAG 3100 and MAG 3100 HT

Selection and Ordering data	Article No.	Selection and Ordering data	Article No.
<b>Sensor SITRANS F M MAG 3100</b>	<b>7 ME 6 3 1 0 -</b>	<b>Sensor SITRANS F M MAG 3100</b>	<b>7 ME 6 3 1 0 -</b>
<b>Diameter</b>		<b>Flange material</b>	
DN 15 (½") (PTFE and PFA liner)	1 V	Carbon steel flanges ASTM A 105	1
DN 25 (1")	2 D	Stainless steel flanges, AISI 304/1.4301	2
DN 40 (1½")	2 R	Stainless steel flanges and sensor body, AISI 316L/1.4404, polished	3
DN 50 (2")	2 Y	<b>Liner material</b>	
DN 65 (2½")	3 F	Soft rubber	1
DN 80 (3")	3 M	EPDM	2
DN 100 (4")	3 T	PTFE (DN ≤ 300, PN ≤ 50 bar / ≤ 12", PN ≤ 725 psi), PTFE (350 ≤ DN ≤ 600, PN ≤ 40 bar / 14" ≤ DN ≤ 24", PN ≤ 580 psi)	3
DN 125 (5")	4 B	Ebonite	4
DN 150 (6")	4 H	Linatex (PN ≤ 40 bar (580 psi) DN ≤ 600 (24"))	5
DN 200 (8")	4 P	PFA (DN 15 ... 150 (½" ... 6")) (PN ≤ 40 bar (580 psi))	7
DN 250 (10")	4 V	<b>Electrode material</b>	
DN 300 (12")	5 D	(Grounding electrodes not for PTFE liner or Pressure PN 100)	
DN 350 (14")	5 K	AISI 316Ti/1.4571 (not for PFA)	1
DN 400 (16")	5 R	Hastelloy C276/2.4819	2
DN 450 (18")	5 Y	(PFA liner: Hastelloy C22/2.4602)	
DN 500 (20")	6 F	Platinum (DN ≤ 300 (12")) (not ebonite liner)	3
DN 600 (24")	6 P	Titanium (not PFA liner) (DN ≤ 600 (24"))	4
DN 700 (28")	6 Y	Tantalum (DN ≤ 600 (24")) (not ebonite liner)	5
DN 750 (30") (AWWA and AS 2129 only)	7 D	Hastelloy C22/2.4602 incl. grounding electrodes (only PFA)	6
DN 800 (32")	7 H	Platinum incl. grounding electrodes (only PFA)	7
DN 900 (36")	7 M	Tantalum incl. grounding electrodes (only PFA)	8
DN 1000 (40")	7 R	<b>Transmitter with display</b>	
DN 1050 (42") (AWWA only)	7 U	Standard sensor for remote transmitter (Order transmitter separately)	A
DN 1100 (44") (AWWA only)	7 V	Ex sensor for remote transmitter (Order transmitter separately)	B
DN 1200 (48")	8 B	MAG 6000 I, Alu. 18 ... 90 V DC, 115 ... 230 V AC	C
DN 1400 (54")	8 F	MAG 6000 I Alu. 18 ... 30 V DC, Ex	D
DN 1500 (60")	8 K	MAG 6000 I Alu. 115 ... 230 V, Ex	E
DN 1600 (66")	8 P	MAG 6000 Polyamide, 11... 30 V DC / 11...24 V AC	H
DN 1800 (72")	8 T	MAG 6000, Polyamide, 115 ... 230 V AC	J
DN 2000 (78")	8 Y	MAG 5000, Polyamide, 11... 30 V DC / 11...24 V AC	K
		MAG 5000, Polyamide, 115 ... 230 V AC	L
<b>Flange norm and pressure rating</b>		<b>Communication</b>	
<u>EN 1092-1</u>		No communication, add-on possible	A
PN 6 (DN 65 ... 2000 (2½" ... 78"))	A	HART	B
PN 10 (DN 200 ... 2000 (8" ... 78"))	B	PROFIBUS PA Profile 3 (only MAG 6000/MAG 6000 I)	F
PN 16 (DN 65 ... 1200 (2½" ... 48"))	C	PROFIBUS DP Profile 3 (not for Ex) (only MAG 6000/MAG 6000 I)	G
PN 16, non-PED (DN 700 ... 2000 (28" ... 78"))	D	Modbus RTU/RS 485 (not for Ex) (only MAG 6000/MAG 6000 I)	E
PN 25 (DN 200 ... 600 (8" ... 24")) <sup>1)</sup>	E	FOUNDATION Fieldbus H1 (only MAG 6000/MAG 6000 I)	J
PN 40 (DN 15 ... 600 (½" ... 24"))	F	<b>Cable glands/terminal box</b>	
PN 63 (DN 50 ... 300 (2" ... 12"))	G	Metric: Polyamide terminal box or 6000 I compact	1
PN 100 (DN 25 ... 300 (1" ... 12"))	H	½" NPT: Polyamide terminal box or 6000 I compact	2
<u>ANSI B16.5</u>		Metric: SS terminal box (mandatory for stainless steel MAG 6000 Transmitter)	3
Class 150 (½" ... 24")	J	½" NPT: SS terminal box (mandatory for stainless steel MAG 6000 Transmitter)	4
Class 300 (½" ... 24")	K		
<u>AWWA C-207</u>			
Class D (28" ... 78")	L		
<u>AS</u>			
2129, table E	M		
4087, PN 16 (DN 50 ... 1200 (2" ... 48")) (Not PTFE and PFA)	N		
4087, PN 21 (DN 50 ... 600 (2" ... 24")) (Not PTFE and PFA)	P		
4087, PN 35 (DN 50 ... 600 (2" ... 24")) (Not PTFE and PFA)	Q		
<u>JIS B 2220:2004</u>			
K10 (1" ... 24")	R		
K20 (1" ... 24")	S		

<sup>1)</sup> Under preparation

◆ We can offer shorter delivery times for configurations designated with the Quick Ship Symbol ◆. For details see page 9/5 in the appendix.

Selection and Ordering data	Order code
<b>Additional information</b>	
Please add “-Z” to Article No. and specify Order code(s) and plain text.	
Factory certificate according to EN 10204-2.2	<b>C14</b>
Factory certificate according to EN 10204-2.1	<b>C15</b>
Tag name plate, stainless steel fixed with SS wire (add plain text)	<b>Y17</b>
Tag name plate, plastic (self adhesive)	<b>Y18</b>
Customer-specific converter setup	<b>Y20</b>
Sensor cables wired (specify cable Article No.)	<b>Y40</b>
Sensor for remote transmitter's junction box potted to IP68 with wired cable (specify cable Article No.) (not for Ex)	<b>Y41</b>
Other postproduction requirements (add desired text)	<b>Y99</b>
Additional calibrations	
• Accredited Siemens Flow Instruments matched pair Calibration acc. to ISO/IEC 17025: 2005	<b>On request<sup>1)</sup></b>
• CT verification and authority seal according to: Cold water pattern approval - DANAK TS 22.36.001, PTB (Denmark and Germany)	<b>On request<sup>1)</sup></b>
• Customer-witnessed calibration Any of above calibration	<b>On request<sup>1)</sup></b>
<p><sup>1)</sup> Ordering On request as dedicated information from the customer on the individual sensors is required. Please fill in the calibration form found on <a href="http://pi.khe.siemens.de/index.aspx?Nr=17460">pi.khe.siemens.de/index.aspx?Nr=17460</a> and send together with the order. (Size dependent restriction on maximum flow rates may apply)</p>	

### Operating instructions for SITRANS F M MAG 3100

Description	Article No.
• English	<b>A5E03005599</b>
• German	<b>A5E03086288</b>
• Spanish	<b>A5E03086291</b>
• French	<b>A5E03086290</b>

This device is shipped with a Quick Start guide and a CD containing further SITRANS F literature.

All literature is also available for free at:  
<http://www.siemens.com/flowdocumentation>

### Accessories

Description	Article No.
Potting kit for terminal box of flow sensors for IP68/NEMA 6P (not for Ex sensors)	<b>FDK:085U0220</b>



◆ We can offer shorter delivery times for configurations designated with the Quick Ship Symbol ◆. For details see page 9/5 in the appendix.

Please use online Product selector to get latest updates.

Product selector link:  
[www.pia-selector.automation.siemens.com](http://www.pia-selector.automation.siemens.com)

MAG 5000/6000 transmitters and sensors are packed in separate boxes, the final assembly takes place during installation at the customer's place. MAG 6000 I/MAG 6000 I ATEX 2G D transmitters and sensors are delivered compact mounted from factory.

Communication module will be pre-mounted in the transmitter.

# Flow Measurement

## SITRANS F M

### Flow sensor MAG 3100 and MAG 3100 HT

Selection and Ordering data	Article No.	Selection and Ordering data	Article No.
<b>Sensor SITRANS F M MAG 3100 HT (High Temperature)</b>	<b>7 ME 6 3 2 0 -</b>	<b>Sensor SITRANS F M MAG 3100 HT (High Temperature)</b>	<b>7 ME 6 3 2 0 -</b>
<b>Diameter</b>		<b>Communication</b>	
DN 15 (½")	1 V	No communication, add-on possible	A
DN 25 (1")	2 D	HART	B
DN 40 (1½")	2 R	PROFIBUS PA Profile 3 (only MAG 6000/MAG 6000 I)	F
DN 50 (2")	2 Y	PROFIBUS DP Profile 3 (only MAG 6000/MAG 6000 I)	G
DN 65 (2½")	3 F	Modbus RTU/RS 485 (only MAG 6000/MAG 6000 I)	E
DN 80 (3")	3 M	FOUNDATION Fieldbus H1 (only MAG 6000/MAG 6000 I)	J
DN 100 (4")	3 T	<b>Cable glands/terminal box</b>	
DN 125 (5")	4 B	Metric: Polyamide terminal box (PTFE 130 °C (266 °F)) or 6000 I compact	1
DN 150 (6")	4 H	½" NPT: Polyamide terminal box (PTFE 130 °C (266 °F)) or 6000 I compact	2
DN 200 (8")	4 P	Metric: SS terminal box (mandatory for Stainless steel MAG 6000 Transmitter)	3
DN 250 (10")	4 V	½" NPT: SS terminal box (mandatory for Stainless steel MAG 6000 Transmitter)	4
DN 300 (12")	5 D		
<b>Flange norm and pressure rating</b>		<b>Selection and Ordering data</b>	Order code
EN 1092-1		<b>Additional information</b>	
PN 10 (DN 200 ... 300 (8" ... 12"))	B	Please add "-Z" to Article No. and specify Order code(s) and plain text.	
PN 16 (DN 65 ... 300 (2½" ... 12"))	C	Factory certificate according to EN 10204-2.2	C14
PN 25 (DN 200 ... 300 (8" ... 12"))	E	Factory certificate according to EN 10204-2.1	C15
PN 40 (DN 15 ... 300 (½" ... 12"))	F	Customer-specific converter setup	Y20
<b>ANSI B16.5</b>		Tag name made, stainless steel fixed with SS wire (add plain text)	Y17
Class 150 (½" ... 12")	J	Tag name plate, plastic (self adhesive)	Y18
Class 300 (½" ... 12")	K	Sensor cables wired (specify cable Article No.)	Y40
<b>AS</b>		Sensor for remote transmitter's junction box potted to IP68 with wired cable (specify cable Article No.) (not for Ex)	Y41
2129, table E	M	Other postproduction requirements (add desired text)	Y99
<b>Flange material</b>		Additional calibrations	
Carbon steel flanges ASTM A 105	1	• Matched pair - (Standard production calibration where sensor and transmitter is calibrated together)	On request <sup>1)</sup>
Stainless steel flanges, AISI 304/1.4301	2	• Accredited Siemens Flow Instruments matched pair Calibration acc. to ISO/IEC 17025: 2005	On request <sup>1)</sup>
Stainless steel flanges and sensor body, AISI 316L/1.4404, polished	3	• Customer-specified calibration up to 10 points	On request <sup>1)</sup>
<b>Liner material</b>		• CT verification and authority seal according to: Cold water pattern approval - DANAK TS 22.36.001, PTB (Denmark and Germany)	On request <sup>1)</sup>
PTFE (130 °C (266 °F))	2	• Customer-witnessed calibration Any of above calibration	On request <sup>1)</sup>
PTFE including type E protection rings	3		
AISI 316/1.4436 (180 °C (356 °F))			
PFA (150 °C (302 °F)) (DN 15 ... 150 (½" ... 6"))	7		
<b>Electrode material</b>			
AISI 316Ti/1.4571 (not for PFA)	1		
Hastelloy C276/2.4819 (PFA liner: Hastelloy C22/2.4602)	2		
Platinum	3		
Titanium (not for PFA)	4		
Tantalum	5		
Hastelloy C22/2.4602 incl. grounding electrodes (only PFA)	6		
Platinum incl. grounding electrodes (only PFA)	7		
Tantalum incl. grounding electrodes (only PFA)	8		
<b>Transmitter with display</b>			
Standard sensor for remote transmitter (Order transmitter separately)	A		
Ex sensor for remote transmitter (Order transmitter separately)	B		
MAG 6000 I, Alu. 18 ... 90 V DC, 115 ... 230 V AC	C		
MAG 6000 I, Alu. 18 ... 30 V DC, Ex	D		
MAG 6000 I, Alu. 115 ... 230 V AC, Ex	E		
MAG 6000, Polyamide, 11 ... 30 V DC/ 11 ... 24 V AC	H		
MAG 6000, Polyamide, 115 ... 230 V AC	J		
MAG 5000, Polyamide, 11 ... 30 V DC/ 11 ... 24 V AC	K		
MAG 5000, Polyamide, 115 ... 230 V AC	L		

icenta Controls Ltd



**Selection and Ordering data****MAG 3100 and MAG 3100 HT<sup>1)</sup> Type C Grounding and protection rings**

1 pc. AISI 304 grounding and protection ring **type C** for all liners except PTFE and PFA

Type C

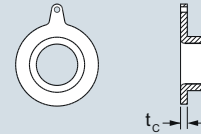

DN	PN 6 Article No.	PN 10 Article No.	PN 16 Article No.	PN 25 Article No.	PN 40 Article No.	AS 2129 Table E Article No.
DN 25					FDK:083N8361	FDK:083N8361
DN 40					FDK:083N8362	FDK:083N8362
DN 50					FDK:083N8344	FDK:083N8344
DN 65	FDK:083N8345		FDK:083N8345		FDK:083N8345	FDK:083N8346
DN 80	FDK:083N8347		FDK:083N8347		FDK:083N8347	FDK:083N8347
DN 100	FDK:083N8070		FDK:083N8025		FDK:083N8025	FDK:083N8025
DN 125	FDK:083N8071		FDK:083N8071		FDK:083N8071	FDK:083N8071
DN 150	FDK:083N8072		FDK:083N8008		FDK:083N8008	FDK:083N8008
DN 200	FDK:083N8074	FDK:083N8011	FDK:083N8011	FDK:083N8011	FDK:083N8075	FDK:083N8011
DN 250	FDK:083N8078	FDK:083N8013	FDK:083N8013	FDK:083N8013	FDK:083N8079	FDK:083N8013
DN 300	FDK:083N8080	FDK:083N8012	FDK:083N8012	FDK:083N8081	FDK:083N8082	FDK:083N8012
DN 350	FDK:083N8083	FDK:083N8039	FDK:083N8039	FDK:083N8084	FDK:083N8085	FDK:083N8039
DN 400	FDK:083N8099	FDK:083N8100	FDK:083N8100	FDK:083N8101	FDK:083N8102	FDK:083N8100
DN 450	FDK:083N8103	FDK:083N8103	FDK:083N8104	FDK:083N8104	FDK:083N8105	FDK:083N8104
DN 500	FDK:083N8107	FDK:083N8107	FDK:083N8108	FDK:083N8108	FDK:083N8109	FDK:083N8108
DN 600	FDK:083N8111	FDK:083N8111	FDK:083N8112	FDK:083N8112		FDK:083N8113
DN 700	FDK:083N8300	FDK:083N8294	FDK:083N8294			FDK:083N8372
DN 750						
DN 800	FDK:083N8303	FDK:083N8304	FDK:083N8304			FDK:083N8373
DN 900	FDK:083N8306	FDK:083N8307	FDK:083N8307			FDK:083N8396
DN 1000	FDK:083N8309	FDK:083N8310	FDK:083N8310			FDK:083N8397
DN 1100		FDK:083N8367	FDK:083N8367			FDK:083N8367
DN 1200	FDK:083N8312	FDK:083N8313	FDK:083N8313			FDK:083N8398
DN 1400	FDK:083N8467	FDK:083N8468	FDK:083N8469			
DN 1500	FDK:083N8471	FDK:083N8472	FDK:083N8473			
DN 1600	FDK:083N8475	FDK:083N8476	FDK:083N8477			
DN 1800	FDK:083N8479	FDK:083N8480	FDK:083N8481			
DN 2000	FDK:083N8483	FDK:083N8484	FDK:083N8485			

<sup>1)</sup> Also for MAG 5100 W (7ME6520 > DN 300; and 7ME6580).

Size	ANSI Class 150 Article No.	Class 300 Article No.	JIS K10 Article No.	JIS K20 Article No.	Size	AWWA C-207 Article No.
1"	FDK:083N8361	FDK:083N8361	FDK:083N8361	FDK:083N8361	28"	FDK:083N8302
1½"	FDK:083N8362	FDK:083N8362	FDK:083N8362	FDK:083N8362	30"	FDK:083N8366
2"	FDK:083N8344	FDK:083N8344	FDK:083N8344	FDK:083N8344	32"	FDK:083N8305
2½"	FDK:083N8345	FDK:083N8345	FDK:083N8345	FDK:083N8345	36"	FDK:083N8308
3"	FDK:083N8347	FDK:083N8347	FDK:083N8347	FDK:083N8347	40"	FDK:083N8311
4"	FDK:083N8025	FDK:083N8025	FDK:083N8070	FDK:083N8025	42"	FDK:083N8394
5"	FDK:083N8071	FDK:083N8071	FDK:083N8071	FDK:083N8071	44"	FDK:083N8395
6"	FDK:083N8008	FDK:083N8073	FDK:083N8008	FDK:083N8008	48"	FDK:083N8314
8"	FDK:083N8011	FDK:083N8076	FDK:083N8011	FDK:083N8011	54"	FDK:083N8470
10"	FDK:083N8013	FDK:083N8079	FDK:083N8013	FDK:083N8079	60"	FDK:083N8474
12"	FDK:083N8012	FDK:083N8082	FDK:083N8012	FDK:083N8081	66"	FDK:083N8478
14"	FDK:083N8039	FDK:083N8085	FDK:083N8083	FDK:083N8039	72"	FDK:083N8482
16"	FDK:083N8100	FDK:083N8102	FDK:083N8100	FDK:083N8101	78"	FDK:083N8486
18"	FDK:083N8104	FDK:083N8106	FDK:083N8103	FDK:083N8104		
20"	FDK:083N8107	FDK:083N8110	FDK:083N8107	FDK:083N8108		
24"	FDK:083N8113	FDK:083N8114	FDK:083N8111	FDK:083N8112		

# Flow Measurement

## SITRANS F M

### Flow sensor MAG 3100 and MAG 3100 HT

#### Selection and Ordering data

##### MAG 3100 and 3100 HT Type E grounding and protection ring

1 pc. AISI 316 grounding and protection ring **type E** for PTFE liners

#### Note:

For MAG 3100 HT High temperature version 7ME6320... for PTFE 180 °C (356 °C) versions - grounding ring type E is included and factory mounted.

Type E

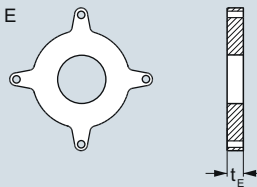

DN	PN 6 Article No.	PN 10 Article No.	PN 16 Article No.	PN 25 Article No.	PN 40 Article No.
DN 15					FDK:083N8365
DN 25					FDK:083N8271
DN 40					FDK:083N8278
DN 50					FDK:083N8282
DN 65	FDK:083N8284		FDK:083N8285		FDK:083N8286
DN 80	FDK:083N8288		FDK:083N8289		FDK:083N8290
DN 100	FDK:083N8116		FDK:083N8117		FDK:083N8118
DN 125	FDK:083N8120		FDK:083N8121		FDK:083N8122
DN 150	FDK:083N8124		FDK:083N8125		FDK:083N8126
DN 200	FDK:083N8129	FDK:083N8130	FDK:083N8130	FDK:083N8131	FDK:083N8132
DN 250	FDK:083N8135	FDK:083N8136	FDK:083N8137	FDK:083N8138	FDK:083N8139
DN 300	FDK:083N8144	FDK:083N8144	FDK:083N8145	FDK:083N8146	FDK:083N8147
DN 350	FDK:083N8152	FDK:083N8153	FDK:083N8154	FDK:083N8155	FDK:083N8156
DN 400	FDK:083N8160	FDK:083N8161	FDK:083N8162	FDK:083N8163	FDK:083N8164
DN 450	FDK:083N8168	FDK:083N8169	FDK:083N8170	FDK:083N8171	FDK:083N8172
DN 500	FDK:083N8177	FDK:083N8178	FDK:083N8179	FDK:083N8180	FDK:083N8181
DN 600	FDK:083N8186	FDK:083N8187	FDK:083N8188	FDK:083N8189	

Protection of PTFE liner use 2 pcs.

Earthing of PTFE lined flowmeter use 1 pc.

Size	ANSI Class 150 Article No.	Class 300 Article No.	JIS K10 Article No.	JIS K20 Article No.
½"	FDK:083N8365	FDK:083N8365		
1"	FDK:083N8272	FDK:083N8272	FDK:083N8271	FDK:083N8271
1½"	FDK:083N8279	FDK:083N8279	FDK:083N8278	FDK:083N8278
2"	FDK:083N8283	FDK:083N8283	FDK:083N8282	FDK:083N8282
2½"	FDK:083N8287	FDK:083N8287	FDK:083N8285	FDK:083N8285
3"	FDK:083N8291	FDK:083N8292	FDK:083N8288	FDK:083N8289
4"	FDK:083N8118	FDK:083N8119	FDK:083N8116	FDK:083N8117
5"	FDK:083N8122	FDK:083N8123	FDK:083N8121	FDK:083N8122
6"	FDK:083N8126	FDK:083N8127	FDK:083N8125	FDK:083N8126
8"	FDK:083N8370	FDK:083N8133	FDK:083N8130	FDK:083N8370
10"	FDK:083N8140	FDK:083N8141	FDK:083N8137	FDK:083N8139
12"	FDK:083N8148	FDK:083N8149	FDK:083N8144	FDK:083N8146
14"	FDK:083N8157	FDK:083N8158	FDK:083N8152	FDK:083N8154
16"	FDK:083N8165	FDK:083N8166	FDK:083N8160	FDK:083N8165
18"	FDK:083N8173	FDK:083N8174	FDK:083N8169	FDK:083N8171
20"	FDK:083N8182	FDK:083N8183	FDK:083N8178	FDK:083N8180
24"	FDK:083N8190	FDK:083N8191	A5E32709738	A5E32710253

Protection of PTFE liner use 2 pcs.

Grounding of PTFE lined flowmeter use 1 pc.

#### AS2129, Table E

DN	Article No.
DN 15	FDK:083N8365
DN 25	FDK:083N8272
DN 40	FDK:083N8280
DN 50	FDK:083N8281
DN 65	FDK:083N8284
DN 80	FDK:083N8293
DN 100	FDK:083N8117
DN 125	FDK:083N8121
DN 150	FDK:083N8128
DN 200	FDK:083N8134
DN 250	FDK:083N8143
DN 300	FDK:083N8151
DN 350	FDK:083N8153
DN 400	FDK:083N8161
DN 450	FDK:083N8176
DN 500	FDK:083N8185
DN 600	A5E32710253

Protection of PTFE liner use 2 pcs.

Grounding of PTFE lined flowmeter use 1 pcs.

#### Selection and Ordering data

##### MAG 3100 and MAG 3100 HT type E grounding and protecting ring

1 pc. Hastelloy C276 grounding and protection ring **type E** for PTFE liners

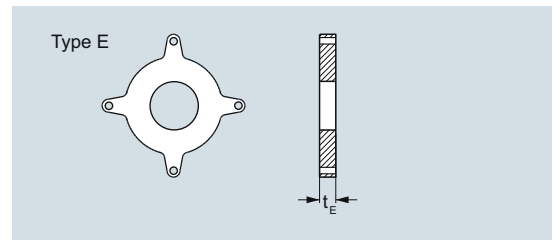

DN	PN 6	PN 16	PN 40	Size	ANSI	ANSI
	Article No.	Article No.	Article No.		Class 150	Class 300
					Article No.	Article No.
DN 15			<b>FDK:083N8487</b>	½"	<b>FDK:083N8487</b>	<b>FDK:083N8487</b>
DN 25			<b>FDK:083N8488</b>	1"	<b>FDK:083N8489</b>	<b>FDK:083N8489</b>
DN 40			<b>FDK:083N8490</b>	1½"	<b>FDK:083N8491</b>	<b>FDK:083N8491</b>
DN 50			<b>FDK:083N8492</b>	2"	<b>FDK:083N8493</b>	<b>FDK:083N8493</b>
DN 65	<b>FDK:083N8494</b>	<b>FDK:083N8495</b>	<b>FDK:083N8496</b>	2½"	<b>FDK:083N8497</b>	<b>FDK:083N8497</b>
DN 80	<b>FDK:083N8498</b>	<b>FDK:083N8499</b>	<b>FDK:083N8500</b>	3"	<b>FDK:083N8501</b>	<b>FDK:083N8502</b>
DN 100	<b>FDK:083N8503</b>	<b>FDK:083N8504</b>	<b>FDK:083N8505</b>	4"	<b>FDK:083N8506</b>	<b>FDK:083N8507</b>

#### Selection and Ordering data

##### MAG 3100 and MAG 3100 HT<sup>1)</sup> Grounding rings: Flat rings

1 pc. **AISI 316** grounding **flat ring** for all liners (PTFE max. 130 °C (266 °F))

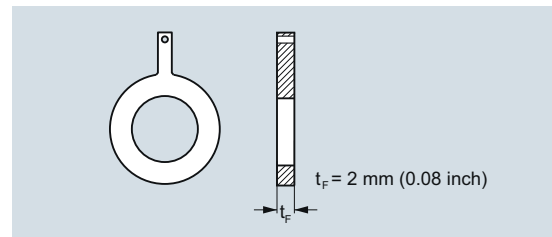

DN	PN 10	PN 16	PN 40	Size	ANSI	ANSI
	Article No.	Article No.	Article No.		Class 150	Class 300
					Article No.	Article No.
DN 15			<b>A5E01191969</b>	½"	<b>A5E01191968</b>	
DN 25			<b>A5E01150880</b>	1"	<b>A5E01150022</b>	<b>A5E01150378</b>
DN 40			<b>A5E01191952</b>	1½"	<b>A5E01191961</b>	
DN 50			<b>A5E01150918</b>	2"	<b>A5E01151121</b>	<b>A5E01151194</b>
DN 65		<b>A5E01191940</b>	<b>A5E01191954</b>	2½"	<b>A5E01191962</b>	
DN 80		<b>A5E01152876</b>	<b>A5E01152876</b>	3"	<b>A5E01152910</b>	<b>A5E01153422</b>
DN 100		<b>A5E01158875</b>	<b>A5E01159072</b>	4"	<b>A5E01159146</b>	<b>A5E01159628</b>
DN 125		<b>A5E01191941</b>	<b>A5E01191956</b>	5"	<b>A5E01191963</b>	
DN 150		<b>A5E01191943</b>	<b>A5E01191957</b>	6"	<b>A5E01191964</b>	
DN 200	<b>A5E01191951</b>	<b>A5E01191944</b>	<b>A5E01191958</b>	8"	<b>A5E01191965</b>	
DN 250	<b>A5E01191950</b>	<b>A5E01191946</b>	<b>A5E01191959</b>	10"	<b>A5E01191966</b>	
DN 300	<b>A5E01191949</b>	<b>A5E01191947</b>	<b>A5E01191960</b>	12"	<b>A5E01191967</b>	

<sup>1)</sup> Also for MAG 5100 W (7ME6520 DN 40 ... 300)

# Flow Measurement

## SITRANS F M

### Flow sensor MAG 3100 and MAG 3100 HT

#### Selection and Ordering data

##### MAG 3100 and MAG 3100 HT Grounding rings : Flat rings

1 pc. **Hastelloy** C276 grounding **flat ring** for all liners (PTFE max. 130 °C (266 °F))

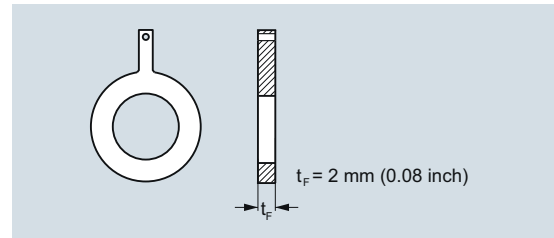

DN	PN 10 Article No.	PN 16 Article No.	PN 40 Article No.	Size	ANSI Class 150 Article No.	Class 300 Article No.
DN 15			<b>A5E01191981</b>	½"	<b>A5E01191989</b>	
DN 25			<b>A5E01150882</b>	1"	<b>A5E01150028</b>	<b>A5E01150379</b>
DN 40			<b>A5E01191982</b>	1½"	<b>A5E01191990</b>	
DN 50			<b>A5E01150922</b>	2"	<b>A5E01151124</b>	<b>A5E01151197</b>
DN 65		<b>A5E01191971</b>	<b>A5E01191983</b>	2½"	<b>A5E01191991</b>	
DN 80		<b>A5E01152889</b>	<b>A5E01152889</b>	3"	<b>A5E01152913</b>	<b>A5E01153424</b>
DN 100		<b>A5E01158886</b>	<b>A5E01159074</b>	4"	<b>A5E01159150</b>	<b>A5E01159629</b>
DN 125		<b>A5E01191973</b>	<b>A5E01191984</b>	5"	<b>A5E01191992</b>	
DN 150		<b>A5E01191974</b>	<b>A5E01191985</b>	6"	<b>A5E01191993</b>	
DN 200	<b>A5E01191978</b>	<b>A5E01191975</b>	<b>A5E01191986</b>	8"	<b>A5E01191994</b>	
DN 250	<b>A5E01191979</b>	<b>A5E01191976</b>	<b>A5E01191987</b>	10"	<b>A5E01191995</b>	
DN 300	<b>A5E01191980</b>	<b>A5E01191977</b>	<b>A5E01191988</b>	12"	<b>A5E01191996</b>	

#### Selection and Ordering data

##### MAG 3100 and MAG 3100 HT Grounding rings : Flat rings

1 pc. **Tantalum** grounding **flat ring** for all liners (PTFE max. 130 °C (266 °F))

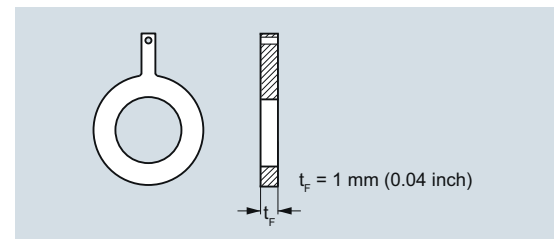

DN	PN 16 Article No.	PN 40 Article No.	Size	ANSI Class 150 Article No.	Class 300 Article No.
DN 15		<b>A5E01192007</b>	½"	<b>A5E01192010</b>	
DN 25		<b>A5E01150883</b>	1"	<b>A5E01150030</b>	<b>A5E01150381</b>
DN 40		<b>A5E01192008</b>	1½"	<b>A5E01192011</b>	
DN 50		<b>A5E01150926</b>	2"	<b>A5E01151129</b>	<b>A5E01151199</b>
DN 65	<b>A5E01192005</b>	<b>A5E01192009</b>	2½"	<b>A5E01192012</b>	
DN 80	<b>A5E01152890</b>	<b>A5E01152890</b>	3"	<b>A5E01152916</b>	<b>A5E01153427</b>
DN 100	<b>A5E01158891</b>	<b>A5E01159076</b>	4"	<b>A5E01159156</b>	<b>A5E01159631</b>

### Dimensional drawings

#### MAG 3100 and MAG 3100 HT sensor with compact or remote transmitter

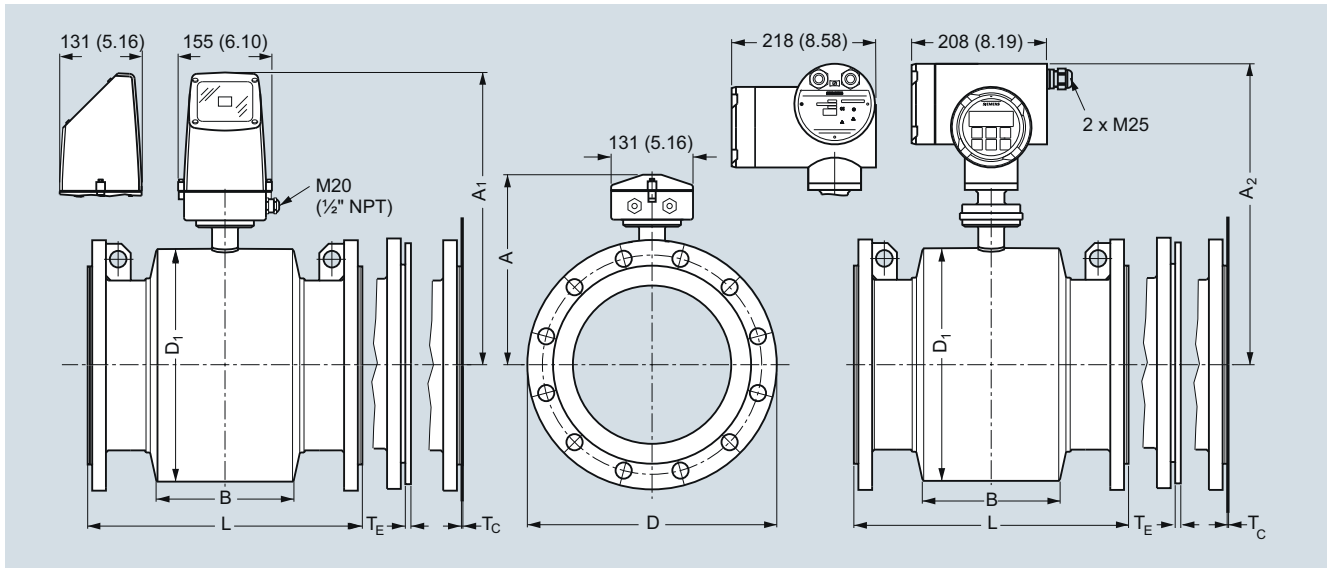

Dimensions in mm (inch)

#### Metric

DN	A <sup>1)</sup>	A <sub>1</sub>	A <sub>2</sub>	B	D <sub>1</sub>	L <sup>2)</sup>						ANSI 16.5/ASME B16.47 <sup>3)</sup>		
						EN 1092-1-201		PN 25	PN 40	PN 63	PN 100	Class 150	Class 300	Class 600
[mm]	[mm]	[mm]	[mm]	[mm]	[mm]	[mm]	[mm]							
15	187	341	338	59	104	-	-	-	200	-	-	200	200	-
25	187	341	338	59	104	-	-	-	200	-	260	200	200	280
40	197	351	348	82	124	-	-	-	200	-	280	200	200	320
50	205	359	356	72	139	-	-	-	200	276	300	200	200	330
65	212	366	363	72	154	200	200/-	-	200	320	350	200	272	on request
80	222	376	373	72	174	200	200/-	-	272 <sup>4)</sup>	323	340	272 <sup>4)</sup>	272 <sup>4)</sup>	350
100	242	396	393	85	214	250	250/-	-	250	380	400	250	310	460
125	255	409	406	85	239	250	250/-	-	250	420	450	250	335	480
150	276	430	427	85	282	300	300/-	-	300	415	450	300	300	500
200	304	458	455	137	338	350	350/-	350	350	480	530	350	350	600
250	332	486	483	157	393	450	450/-	450	450	550	620	450	450	600
300	357	511	508	157	444	500	500/-	500	500	600	680	500	500	700
350	362	516	513	270	451	550	550/-	550	550	-	-	550	550	-
400	387	541	538	270	502	600	600/-	600	600	-	-	600	600	-
450	418	572	569	310	563	600	600/-	600	600	-	-	600	640	-
500	443	597	594	350	614	600	600/-	625	680	-	-	600	730	-
600	494	648	645	320	715	600	600/-	750	800	-	-	600	860	-
700	544	698	695	450	816	700	875/700	800	-	-	-	800	-	-
750	571	725	722	556	869	-	-/-	-	-	-	-	950	-	-
800	606	760	757	560	927	800	1000/800	900	-	-	-	900	-	-
900	653	807	804	630	1032	900	1125/900	1000	-	-	-	1100	-	-
1000	704	858	855	670	1136	1000	1250/1000	1100	-	-	-	1100	-	-
1050	704	858	855	670	1136	-	-/-	-	-	-	-	-	-	-
1100	755	904	901	770	1238	-	-/-	-	-	-	-	-	-	-
1200	810	964	961	792	1348	1200	1500/1200	1300	-	-	-	1400	-	-
1400	925	1079	1076	1000	1574	1400	-/1400	-	-	-	-	-	-	-
1500	972	1126	1123	1020	1672	1500	-/1500	-	-	-	-	-	-	-
1600	1025	1179	1176	1130	1774	1600	-/1600	-	-	-	-	-	-	-
1800	1123	1277	1274	1250	1974	1800	-/1800	-	-	-	-	-	-	-
2000	1223	1377	1374	1375	2174	2000	-/2000	-	-	-	-	-	-	-

1) 14.5 mm shorter with AISI terminal box (Ex and high temperature version)

2) When earthing flanges are used, the thickness of the earthing flange must be added to the built-in length

3) ANSI 16.5 for DN ≤ 600; ASME B16.47 for DN ≥ 700

4) Not according to ISO 13359

# Flow Measurement

## SITRANS F M

### Flow sensor MAG 3100 and MAG 3100 HT

DN	L <sup>1)</sup>				T <sub>C</sub> <sup>2)</sup>	T <sub>E</sub> <sup>2)</sup>	T <sub>F</sub> <sup>2)</sup>	T <sub>I</sub> <sup>2)</sup>	Wgt. <sup>3)</sup>
	AS 2129 E AS 4087 PN 16, 21, 35	AWWA C-207 Class D	JIS K10	JIS K20					
[mm]	[mm]	[mm]	[mm]	[mm]	[mm]	[mm]	[mm]	[mm]	[kg]
15	200	-	200	200	-	6	2	1	4
25	200	-	200	200	1.2	6	2	1	5
40	200	-	200	240	1.2	6	2	1	8
50	200	-	200	240	1.2	6	2	1	9
65	200	-	200	272	1.2	6	2	1	11
80	200 <sup>4)</sup>	-	200 <sup>8)</sup>	272 <sup>8)</sup>	1.2	6	2	1	12
100	250	-	250	310	1.2	6	2	1	16
125	250	-	250	335	1.2	6	2	-	19
150	300	-	300	300	1.2	6	2	-	27
200	350	-	350	350	1.2	8	2	-	40
250	450	-	450	450	1.2	8	2	-	60
300	500	-	500	500	1.6	8	2	-	80
350	550	-	550	550	1.6	8	-	-	110
400	600	-	600	600	1.6	10	-	-	125
450	600	-	600	640	1.6	10	-	-	175
500	600 <sup>5)</sup>	-	600	680	1.6	10	-	-	200
600	600 <sup>6)</sup>	-	600	800	1.6	10	-	-	287
700	700 <sup>7)</sup>	700	-	-	2.0	-	-	-	330
750	750 <sup>7)</sup>	750	-	-	2.0	-	-	-	360
800	800 <sup>7)</sup>	800	-	-	2.0	-	-	-	450
900	900 <sup>7)</sup>	900	-	-	2.0	-	-	-	530
1000	1000 <sup>7)</sup>	1000	-	-	2.0	-	-	-	660
1050	-	1050	-	-	2.0	-	-	-	660
1100	-	1100	-	-	2.0	-	-	-	1140
1200	1200 <sup>7)</sup>	1200	-	-	2.0	-	-	-	1180
1400	-	1400	-	-	2.0	-	-	-	1600
1500	-	1500	-	-	3.0	-	-	-	2460
1600	-	1600	-	-	3.0	-	-	-	2525
1800	-	1800	-	-	3.0	-	-	-	2930
2000	-	2000	-	-	3.0	-	-	-	3665

<sup>1)</sup> When earthing flanges are used, the thickness of the earthing flange must be added to the built-in length

<sup>2)</sup> T<sub>C</sub> = Type C grounding ring, T<sub>E</sub> = Type E grounding ring (Included and factory mounted on high temperature 180 °C PTFE sensor),  
T<sub>F</sub> = Flat type grounding rings

<sup>3)</sup> Weights are approx. (for PN 16) without transmitter

<sup>4)</sup> PN 35 DN 80 = 272 mm (not according to ISO 13359)

<sup>5)</sup> PN 35 DN 500 = 680 mm

<sup>6)</sup> PN 35 DN 600 = 750 mm

<sup>7)</sup> Not AS 4087 PN 21 or PN 35

<sup>8)</sup> Not according to ISO 13359

- not available

D = Outside diameter of flange, see flange tables

#### MAG 3100 and MAG 3100 HT sensor with compact or remote transmitter

##### Imperial

Size	A <sup>1)</sup>	A <sub>1</sub>	A <sub>2</sub>	B	D <sub>1</sub>	L <sup>2)</sup>							ANSI 16.5/ASME B16.47 <sup>3)</sup>		
						EN 1092-1-201						Class 150	Class 300	Class 600	
						PN 6, 10	PN 16/ PN 16 non PED	PN 25	PN 40	PN 63	PN 100				
[inch]	[inch]	[inch]	[inch]	[inch]	[inch]	[inch]	[inch]	[inch]	[inch]	[inch]	[inch]	[inch]	[inch]	[inch]	
½	7.36	13.31	13.25	2.32	4.09	-	-	-	7.87	-	-	7.87	7.87	-	
1	7.36	13.31	13.25	2.32	4.09	-	-	-	7.87	-	10.24	7.87	7.87	11.02	
1½	7.76	13.70	13.64	3.23	4.88	-	-	-	7.87	-	11.02	7.87	7.87	12.60	
2	8.07	14.01	13.95	2.83	5.47	-	-	-	7.87	10.87	11.81	7.87	7.87	12.99	
2½	8.35	14.29	14.23	2.83	6.06	7.87	7.87/-	-	7.87	12.60	13.78	7.87	10.71	on request	
3	8.74	14.69	14.63	2.83	6.85	7.87	7.87/-	-	10.71 <sup>4)</sup>	12.72	13.39	10.71 <sup>4)</sup>	10.71 <sup>4)</sup>	13.78	
4	9.53	15.47	15.41	3.35	8.43	9.84	9.84/-	-	9.84	14.96	-	9.84	12.20	18.11	
5	10.04	15.98	15.92	3.35	9.41	9.84	9.84/-	-	9.84	16.54	-	9.84	13.10	18.90	
6	10.87	16.81	16.75	5.39	11.10	11.81	11.81/-	-	11.81	16.34	-	11.81	11.81	19.68	
8	11.97	17.91	17.85	5.39	13.31	13.78	13.78/-	13.78	13.78	18.90	-	13.78	13.78	23.62	
10	13.07	19.02	18.96	6.18	15.47	17.72	17.72/-	17.72	17.72	-	-	17.72	17.72	23.62	
12	14.05	20.00	19.94	6.18	17.48	19.69	19.69/-	19.69	19.69	-	-	19.69	19.69	27.56	
14	14.25	20.20	20.14	10.63	17.76	21.65	21.65/-	21.65	21.65	-	-	21.65	21.65	-	
16	15.24	21.18	21.12	10.63	19.76	23.62	23.62/-	23.62	23.62	-	-	23.62	23.62	-	
18	16.45	22.40	22.34	12.20	22.16	23.62	23.62/-	23.62	23.62	-	-	23.62	23.62	-	
20	17.44	23.39	23.33	13.78	24.17	23.62	23.62/-	24.61	26.77	-	-	23.62	28.70	-	
24	19.45	25.39	25.33	12.59	28.15	23.62	23.62/-	29.53	31.50	-	-	23.62	33.80	-	
28	21.42	27.36	27.30	17.72	32.13	27.56	34.45/27.56	31.50	-	-	-	31.50	-	-	
30	22.48	28.43	28.37	21.89	34.21	-	-/-	-	-	-	-	37.41	-	-	
32	23.86	29.80	29.74	22.05	36.50	31.50	39.37/31.50	35.44	-	-	-	35.44	-	-	
36	25.71	31.65	31.59	24.80	40.63	35.43	44.29/35.43	39.38	-	-	-	43.32	-	-	
40	27.72	35.67	35.61	26.38	44.72	39.37	49.21/39.37	43.32	-	-	-	43.32	-	-	
42	27.72	35.67	35.61	26.38	44.72	-	-/-	-	-	-	-	-	-	-	
44	29.72	35.67	35.61	30.31	48.74	-	-/-	-	-	-	-	-	-	-	
48	31.89	37.83	37.77	31.18	53.07	47.24	59.06/47.24	51.19	-	-	-	55.12	-	-	
54	36.42	42.36	42.30	39.37	61.97	55.12	-/55.12	-	-	-	-	-	-	-	
60	38.27	44.21	44.15	40.15	65.83	59.06	59.06/59.06	-	-	-	-	-	-	-	
66	40.35	46.30	46.24	44.49	69.84	62.99	-/62.99	-	-	-	-	-	-	-	
72	44.21	50.16	50.10	49.21	77.72	70.87	-/70.87	-	-	-	-	-	-	-	
78	48.15	54.09	54.03	54.13	85.59	78.74	-/78.74	-	-	-	-	-	-	-	

1) 0.571 inch shorter with AISI terminal box (Ex and high temperature version)

2) When earthing flanges are used, the thickness of the earthing flange must be added to the built-in length

3) ANSI 16.5 for DN ≤ 24"; ASME B16.47 for DN ≥ 28"

4) Not according to ISO 13359

# Flow Measurement

## SITRANS F M

### Flow sensor MAG 3100 and MAG 3100 HT

Size	L <sup>1)</sup>				T <sub>C</sub> <sup>2)</sup>	T <sub>E</sub> <sup>2)</sup>	T <sub>F</sub> <sup>2)</sup>	T <sub>T</sub> <sup>2)</sup>	Weight <sup>3)</sup>
	AS 2129 E AS 4087 PN 16, 21, 35	AWWA C-207 Class D	JIS K10	JIS K20					
[in.]	[inch]	[inch]	[inch]	[inch]	[inch]	[inch]	[inch]	[inch]	[lb]
½	7.87	-	7.87	7.87	-	0.24	0.08	0.04	9
1	7.87	-	7.87	7.87	0.05	0.24	0.08	0.04	11
1½	7.87	-	7.87	9.44	0.05	0.24	0.08	0.04	17
2	7.87	-	7.87	9.44	0.05	0.24	0.08	0.04	20
2½	7.87	-	7.87	10.70	0.05	0.24	0.08	0.04	24
3	7.87 <sup>4)</sup>	-	7.87 <sup>8)</sup>	10.70 <sup>8)</sup>	0.05	0.24	0.08	0.04	26
4	9.84	-	9.84	12.20	0.05	0.24	0.08	0.04	35
5	9.84	-	9.84	13.18	0.05	0.24	0.08	-	42
6	11.81	-	11.81	11.81	0.05	0.24	0.08	-	60
8	13.78	-	13.77	13.77	0.05	0.31	0.08	-	88
10	17.72	-	17.71	17.71	0.05	0.31	0.08	-	132
12	19.69	-	19.68	19.68	0.06	0.31	0.08	-	176
14	21.65	-	21.65	21.65	0.06	0.31	-	-	242
16	23.62	-	23.62	23.62	0.06	0.39	-	-	275
18	23.62	-	23.62	25.19	0.06	0.39	-	-	385
20	23.62 <sup>5)</sup>	-	23.62	26.77	0.06	0.39	-	-	440
24	23.62 <sup>6)</sup>	-	23.62	31.49	0.06	0.39	-	-	633
28	27.56 <sup>7)</sup>	27.56	-	-	0.08	-	-	-	728
30	29.53 <sup>7)</sup>	29.52	-	-	0.08	-	-	-	794
32	31.50 <sup>7)</sup>	31.50	-	-	0.08	-	-	-	992
36	35.43 <sup>7)</sup>	35.43	-	-	0.08	-	-	-	1168
40	39.37 <sup>7)</sup>	39.37	-	-	0.08	-	-	-	1455
42	-	39.37	-	-	0.08	-	-	-	1455
44	-	43.31	-	-	0.08	-	-	-	2513
48	47.24 <sup>7)</sup>	47.24	-	-	0.08	-	-	-	2601
54	-	55.12	-	-	0.12	-	-	-	3528
60	-	59.06	-	-	0.12	-	-	-	5423
66	-	63.00	-	-	0.12	-	-	-	5566
72	-	70.87	-	-	0.12	-	-	-	6460
78	-	78.74	-	-	0.12	-	-	-	8080

1) When earthing flanges are used, the thickness of the earthing flange must be added to the built-in length

2) T<sub>C</sub> = Type C grounding ring, T<sub>E</sub> = Type E grounding ring (Included and factory mounted on high temperature 356 °F PTFE sensor), T<sub>F</sub> = Flat type grounding rings

3) Weights are for ANSI 150 without transmitter

4) PN 35 DN 80 = 10.70 inch

5) PN 35 DN 500 = 26.77 inch

6) PN 35 DN 600 = 29.53 inch

7) Not AS 4087 PN 21 or PN 35

8) Not according to ISO 13359

- not available

D = Outside diameter of flange, see flange tables