



The Signet 2537 Flowmeter is the next generation in fluid measurement technology from the inventor of the original paddlewheel flowmeter. This sensor is an improvement on what's already an industry standard. It has the added functionality of various output options including flow switch, multi-functional pulse, digital (S³L) or 4 to 20 mA. Additionally, it offers low flow, low power and high resolution and can be configured on-site directly through the built-in user interface.

Installation is simple because the Signet 2537 utilizes the same fittings as the popular Signet 515 and 2536 Paddlewheel Sensors and fits into pipe sizes ranging from DN15 to DN200 (½ to 8 inches). Available in Polypropylene and PVDF, it is ideal for a variety of applications including chemical processing, water and wastewater monitoring and scrubber control.

Features

- Digital (S³L) or 4 to 20 mA outputs or (Multi-function)
- Allows for up to six sensors to Signet 8900 Multi-Parameter Controller
- Low flow capabilities down to 0.1 m/s (0.3 ft/s)
- Polypropylene or PVDF sensor bodies
- Polypropylene and PVDF retaining nuts standard, Valox optional
- Installs into pipe sizes DN15 to DN200 (½ to 8 in.)
- Test certificate included for -X0, -X1
- Low power and high resolution



Applications

- Process Flow Monitoring
- Pump Protection
- Pure Water Production
- Filtration Systems
- Chemical Production
- Reverse Osmosis
- Demineralization/Regeneration
- Fume Scrubbers
- Cooling Towers
- Proportional Metering Pump

Specifications

General				
Operating Range	0.1 m/s to 6 m/s	0.3 ft/s to 20 ft/s		
Pipe Size Range	DN15 to DN200	½ to 8 in.		
Linearity	±1% of max. range @ 25 °C (77 °F)			
Repeatability	±0.5% of max. range @ 25 °C (77 °F)			
System Response	100 ms update rate nominal			
Wetted Materials				
Sensor Body	Glass-filled PP (black) or PVDF (natural)			
O-rings	FKM (std) optional EPR (EPDM) or FFKM			
Rotor Pin	Titanium, Hastelloy-C or PVDF; optional Ceramic, Tantalum or Stainless Steel			
Rotor	Black PVDF or Natural PVDF; optional ETFE, with or w/o carbon fiber reinforced PTFE sleeve for rotor pin			
Electrical				
Multi	With Dry-Contact Relay	24 VDC nominal, ±10%, regulated, 30 mA max current		
	With Solid-State Relay	6 V to 24 VDC, ±10%, regulated, 30 mA max current		
	Digital (S ³ L)	5.0 VDC min to 6.5 VDC max., 30 mA max current (1.5 mA nominal)		
	4 to 20 mA	400 mV max ripple voltage, 30 mA max current		
	Maximum Pulse Rate	300 Hz		
	Maximum Pulse Width	50 ms		
	Minimum Pulse Rate	0.5 Hz		
	Compatible with PLC, PC or similar equipment			
Compatible with customer supplied metering pump				
Digital (S ³ L) Version	5 VDC nominal, regulated, 3 mA max current			
	Type	Serial ASCII, TTL level 9600 bps		
	Max. Cable Length	Refer to Signet 8900 wiring specifications.		
	Compatible with Model Signet 8900 controller			
4 to 20 mA Version	12 to 32 VDC nominal, ±10%, regulated, 21 mA max current			
	Loop Accuracy	±32 µA @ 25 °C @ 24 VDC)		
	Loop Resolution	5 µA		
	Temp. Drift	±1 µA per °C max.		
	Power Supply Rejection	±1 µA per V		
	Max. Cable	305 m	1000 ft	
	Maximum Loop Resistance	600 Ω @ 24 VDC	1 KΩ @ 32 VDC	
	Load Impedance	375 Ω		
Reverse Polarity and Short Circuit Protected	Up to 40 V, 1 hour			
Over-voltage Protection	> 40 VDC over 1 hour			
Relay Specifications				
	Mechanical SPDT	5 A @ 30 VDC, 5 A @ 250 VAC		
	Solid-State Relay	100 mA @ 40 VDC, 70 mA @ 33 VAC		
	Relay Modes	Low, High		
	Time Delay	0.0 to 6400.0 seconds		
	Hysteresis	Adjustable for exiting alarm condition		
Max. Temperature/Pressure Rating				
Storage Temperature	-10 °C to 75 °C	14 °F to 167 °F		
Operating Temperature	0 °C to 65 °C	32 °F to 149 °F		
Relative Humidity	0 to 90%, non-condensing			
Flow Sensor/ Retaining Nut	PP	12.5 bar @ 20 °C	181 psi @ 68 °F	
		1.7 bar @ 85 °C	25 psi @ 185 °F	
	PVDF	14 bar @ 20 °C	203 psi @ 68 °F	
		1.7 bar @ 85 °C	25 psi @ 185 °F	
Operating Temperature	PP	-18 °C to 85 °C	0 °F to 185 °F	
		PVDF	-18 °C to 85 °C	0 °F to 185 °F
Environmental				
Enclosure	NEMA 4X/IP65			
Shipping Weight				
	0.640 kg	1.41 lb		
Standards and Approvals				
CE, FCC, UL, NSF (3-2537-XC-PX version only)				
RoHS compliant, China RoHS				
Manufactured under ISO 9001 for Quality and ISO 14001 for Environmental Management and OHSAS 18001 for Occupational Health and Safety.				

Dimensions



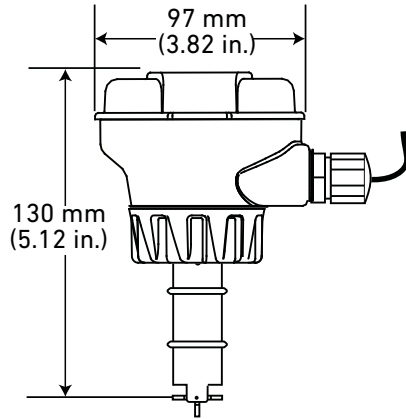



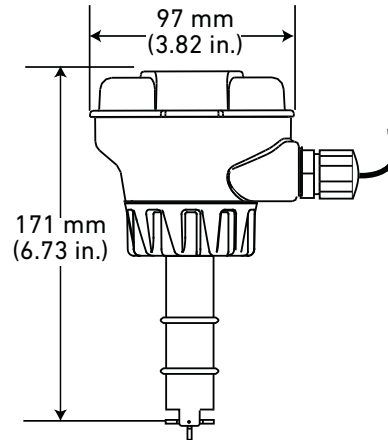



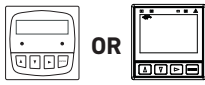

½ in. to 4 in. pipe

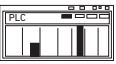

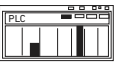
5 to 8 in. pipe

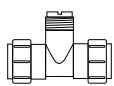

In-Line Installation

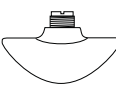
System Overview	Panel Mount	4 to 20 mA Dry Contact, Solid State	4 to 20 Output	Automation System
	Signet Instruments 8900 9900 9900-1BC	Customer Supplied Metering Pump	Customer Supplied Chart Recorder, Programmable Logic Controller , or Programable Automation Controller	0486 Profibus Concentrator and Customer Supplied Programmable Logic Controller or Programmable Automation Controller
	 OR 		 OR 	 + 
Signet 2537 Paddlewheel Flowmeter				
Signet Fittings	    			All sold separately

Application Tips

- Select PVDF Rotor Pin for use in Deionized Water.
- Use a sleeved rotor in abrasive liquids to reduce wear.
- Sensor plug is used to plug installation fitting after extraction of sensor from pipe.
- For liquids containing ferrous particles, use Signet Magmeters.
- For systems with components of more than one material, the maximum temperature/pressure specification must always be referenced to the component with the lowest rating.

Please refer to Wiring, Installation, and Accessories sections for more information.

Ordering Information

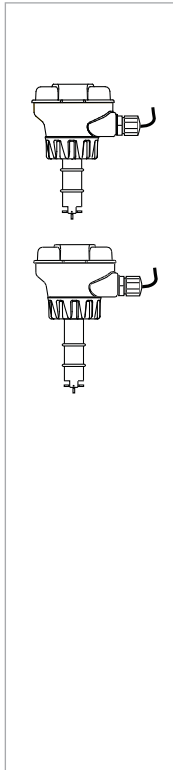

Mfr. Part No.	Code	Output
Paddlewheel Flowmeter - Integral Mount (8512 sensors)		
DN15 to DN100 - ½ to 4 in.		
Polypropylene body, black polypropylene retaining nut, black PVDF rotor, Titanium pin, FKM O-rings		
3-2537-1C-P0	159 001 291	Pulse/Flow Switch DCR
3-2537-2C-P0	159 001 292	Pulse/Flow Switch SSR
3-2537-5C-P0	159 001 295	Digital (S ³ L)
3-2537-6C-P0	159 001 296	4 to 20 mA
Natural PVDF body, natural PVDF retaining nut, rotor and pin, FKM O-rings*		
3-2537-1C-T0	159 001 315	Pulse/Flow Switch DCR
3-2537-2C-T0	159 001 316	Pulse/Flow Switch SSR
3-2537-5C-T0	159 001 319	Digital (S ³ L)
3-2537-6C-T0	159 001 320	4 to 20 mA
DN125 to DN200 - 5 to 8 in.		
Polypropylene body, black polypropylene retaining nut, black PVDF rotor, Titanium pin, FKM O-rings		
3-2537-1C-P1	159 001 303	Pulse/Flow Switch DCR
3-2537-2C-P1	159 001 304	Pulse/Flow Switch SSR
3-2537-5C-P1	159 001 307	Digital (S ³ L)
3-2537-6C-P1	159 001 308	4 to 20 mA

*PVDF available ½ in. to 4 in. only

Accessories and Replacement Parts

Mfr. Part No.	Code	Description
Rotors		
3-2536.320-1	198 820 052	Rotor, PVDF Black
3-2536.320-2	159 000 272	Rotor, PVDF Natural
3-2536.320-3	159 000 273	Rotor, ETFE
3-2536.322-1	198 820 056	Sleeved rotor, PVDF Black
3-2536.322-2	198 820 057	Sleeved rotor, PVDF Natural
3-2536.322-3	198 820 058	Sleeved rotor, ETFE
Rotor Pins		
M1546-1	198 801 182	Pin, Titanium
M1546-2	198 801 183	Pin, Hastelloy-C
M1546-3	198 820 014	Pin, Tantalum
M1546-4	198 820 015	Pin, Stainless Steel
P51545	198 820 016	Pin, Ceramic
O-rings		
1220-0021	198 801 000	O-ring, FKM (2 required per sensor)
1224-0021	198 820 006	O-ring, EPR (EPDM) (2 required per sensor)
1228-0021	198 820 007	O-ring, FFKM (2 required per sensor)
Miscellaneous		
P31536	198 840 201	Sensor plug, Polypropylene
3-2536.321	198 820 054	PVDF Natural, Rotor kit (rotor and pin)
3-8050.390-1	159 001 702	Retaining nut replacement kit, NPT, Valox
3-8050.390-3	159 310 116	Retaining nut replacement kit, NPT, PP
3-8050.390-4	159 310 117	Retaining nut replacement kit, NPT, PVDF
3-8050.396	159 000 617	RC Filter kit (for relay use)
3-9000.392-1	159 000 839	Liquid tight connector kit, NPT (1 piece)
3-9000.392-2	159 000 841	Liquid tight connector kit, PG13.5 (1 piece)
7310-1024	159 873 004	24 VDC Power Supply, 10W, 0.42 A
7310-2024	159 873 005	24 VDC Power Supply, 24W, 1.0 A
7310-4024	159 873 006	24 VDC Power Supply, 40W, 1.7 A
7310-6024	159 873 007	24 VDC Power Supply, 60W, 2.5 A
7310-7024	159 873 008	24 VDC Power Supply, 96W, 4.0 A

ICENTA

Icenta Controls Ltd
 Unit 3 The Woodford Centre
 Lysander Way,
 Old Sarum Park
 Salisbury Wiltshire UK
 SP4 6BU