

DRUM-TYPE GAS METERS

TG 25 STAINLESS STEEL 6 BAR • DATA-SHEET

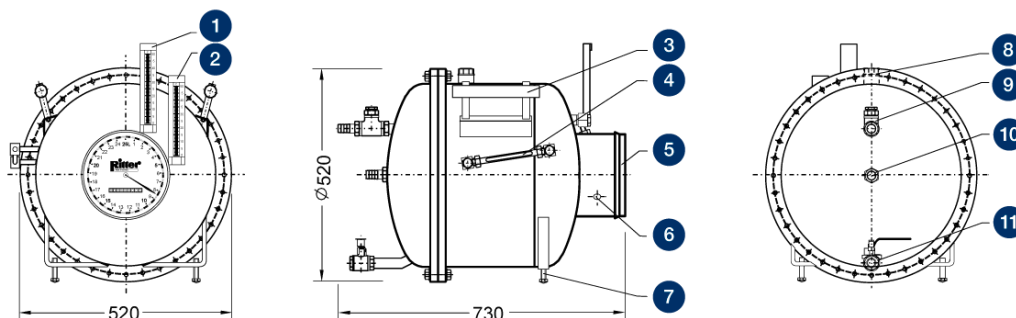

Legend

+

- | | | |
|-----------------------------|-------------------------------------|----------------------------------|
| 1. Thermometer gas (option) | 2. Thermometer packing fl. (option) | 3. Handle |
| 4. Filling level indicator | 5. Removable cover | 6. Pulse generator port (option) |
| 7. Levelling foot | 8. Filling nozzle | 9. Gas inlet |
| 10. Gas outlet | 11. Drainage faucet | |

Performance Data

Minimum flow Q_{\min}	50 ltr/h	Maximum gas inlet pressure	6 bar
Standard flow Q_{standard}	5,000 ltr/h	Minimum differential pressure ⁽¹⁾	0.1 mbar
Maximum flow Q_{\max}	7,000 ltr/h	Minimum dial division	0.2 ltr
Measurement accuracy at standard flow	0.2 %	Maximum indication value ⁽²⁾	999,999,990 ltr
Measurement accuracy across measuring range	0.5 %	Connection gas in/outlet	hose barb
Measuring drum volume	25 ltr/U	Inside-Ø hose barb	18 mm
Packing liquid quantity, approx	42 ltr	Outside-Ø	25 mm

⁽¹⁾ Differential pressure (= pressure loss) gas inlet gas outlet

⁽²⁾ Standard Totalizing Roller Counter

Models (materials)

Model	Casing	Measuring drum	Width	Height	Depth	Weight (without packing liquid)	Max. constant use temperature
1	Stainless Steel	PVC-grey	520 mm	520 mm	730 mm	53.0 kg	40 °C
2	Stainless Steel	PE-el	520 mm	520 mm	730 mm	52.5 kg	60 °C
3	Stainless Steel	PP-grey	520 mm	520 mm	730 mm	52.5 kg	60 °C
4	Stainless Steel	PVDF	520 mm	520 mm	730 mm	54.6 kg	60 °C

Caution

Before and after measurements with **oxygen** purge the meter with an inert gas to avoid the danger of **explosion!**

For chemical resistance properties please contact your RITTER distribution partner!

Standard Equipment

- > 8-digit Totalizing Roller Counter
- > Bubble level for levelling
- > Level and Levelling Feet
- > Magnetic Coupling (between the measuring drum and counting mechanism) , for an absolutely liquid-tight casing
- > Multi-Chamber Measuring Drum
- > Supports for Thermometer and Manometer
- > Viton sealing

Built-in Options

- > Pulse Generator , standard or Ex-proof version (for connecting Electronic Display Unit/Computer)
- > LCD Display , resettable, 8-digit (replaces Totalizing Roller Counter)
- > High Precision Packing Liquid Level Indicator »HPLI« , for packing liquid level

Accessories

- > Data Acquisition Software »RIGAMO« , (for Windows)
- > Thermometer Gas (TG) , measuring range 0 °C to +60 °C
- > Thermometer Packing Liquid (TG) , measuring range 0 °C to +60 °C
- > Manometer for pressure $p_{max} \leq 10$ bar , measuring range 0-6 / 0-10 bar; available for higher pressure ranges
- > Electronic Display Unit »EDU 32 FP« , displays volume and calculates flow rate via RS232 and analog-output in realtime (pulse generator required)

V 1.0 / Rev. 2019-01-15 / Subject to alterations.

The most recent version of this data-sheet can be found at <https://www.ritter.de/en/data-sheets/tg-25-stainless-steel-6-bar/>

Dr.-Ing. RITTER Apparatebau GmbH & Co. KG · Coloniastrasse 19-23 · D-44892 Bochum · Germany

For questions please contact mailbox@ritter.de or your any local distributor at <https://www.ritter.de/en/worldwide/>